

Tools of Algebra: Expressions, Equations & Inequalities

Fast Track GRASP Math Packet Part 2



photo by Julian Povey (Flickr.com)

Version 1.0

Released 6/20/2019



This Fast Track GRASP Math Packet was made possible through support from the New York State Education Department, Office of Adult Career and Continuing Education Services. The Fast Track GRASP Math packets use a Creative Commons license of Attribution-NonCommercial 4.0 International (CC BY-NC 4.0), which means that they can be shared, copied and redistributed in any form, as long as the document retains attribution to CUNY/NYSED for their creation.



Table of Contents

Variables	4
Variable as an Unknown Number	4
Variables Used in Formulas	5
Variables and Mathematical Properties	6
Variables in Inequalities	12
Expressions and Equations II	13
Another Magic Trick	13
Tape Diagrams	14
Like Terms	21
Algebra By Example	28
The Math Behind the Magic Trick II	32
Solving Equations	34
Area Models for Multiplication II	34
Guess My Number II	39
Simplify and Solve	41
Creating and Solving Equations III	42
Solving for Variables	43
Using Formulas	44
Distance, Rate and Time	44
Force, Mass and Acceleration	47
The Pythagorean Theorem	50
Volume of Geometric Figures	52
Systems of Equations	60

Expressions, Equations, and Inequalities (Part 2)

The Sum and Difference Problem	60
The Parking Lot Problem	64
Inequalities	67
Number Sentences That Aren't Balanced	67
Donations for a Class Party	73
Graphing Inequalities	75
Evaluate Inequalities with Variables	82
Creating Inequalities	83
Test Practice Questions	84
The Language of Expressions, Equations, and Inequalities	99
Concept Circle	99
Write a Letter to a Future Student	100
Answer Keys	103
Variables	103
Expressions and Equations II	105
Solving Equations	108
Using Formulas	112
Systems of Equations	115
Inequalities	115
Test Practice Questions	119
The Language of Expressions, Equations, and Inequalities	121
Vocabulary Review	122
Sources	125

Variables

As we read earlier, mathematicians started using letters as variables about 400 years ago. This tool made solving problems more efficient since they could represent unknown quantities without using words. Over time, variables have been used in different ways to communicate mathematical ideas.

The word *variable* comes from a Latin word meaning “something that can change.” In English, to *vary* means to change. For example, if you *vary* your diet, it means that you might eat different kinds of food each day. In mathematics, a *variable* is a symbol (usually a letter) that can represent different values or quantities.

Variables can help us represent numbers that we don’t know yet (like a mystery number). In this situation, the value of the variable doesn’t actually change; we just don’t know what it is yet. There are other ways of using variables when the quantity represented by the variables keeps changing. This section explains some of the different ways variables can be used in mathematics.

Variable as an Unknown Number

When you read instructions like *Solve for x* or a question such as *What is the value of w that makes this equation true?*, the variables x and w are being used to represent unknown numbers.

Here are some examples of equations that use a variable as an unknown number. We practiced solving equations like this in Part I.

$$u + u + 5 = 17$$

$$\frac{v}{2} = 19$$

$$5w + 7 = 47$$

$$5x + 2 = 3x + 8$$

$$y + .75 = 4$$

$$16 = z \cdot z$$

- 1) Find the values of the variables above.

$$u = \underline{\hspace{2cm}}$$

$$v = \underline{\hspace{2cm}}$$

$$w = \underline{\hspace{2cm}}$$

$$x = \underline{\hspace{2cm}}$$

$$y = \underline{\hspace{2cm}}$$

$$z = \underline{\hspace{2cm}} \text{ or } \underline{\hspace{2cm}}$$

Expressions, Equations, and Inequalities (Part 2)

We will also solve equations like these in this packet and the other algebra packets:

$$x^2 = 36$$

$$(w + 2)(w + 4) = 63$$

$$z(z + 5) = 104$$

$$0.25y - 50 = 240$$

$$3v + 7 < 15$$

$$2u + u \geq 90$$

The variables in the equations above represent a specific number or numbers. This means that you can solve the equation to find the values of the variable that makes the number sentences true. In some cases, there may be more than one number that can be substituted for the variable to make the number sentence true. It depends on the number sentence.

Variables Used in Formulas

Letters are often used as variables to represent numbers in *formulas*. A *formula* is a rule or fact written with mathematical symbols. A formula usually has an equals sign and two or more variables. For example, here are a few formulas from geometry that you may be familiar with:

$$A = L \times W$$

The area of a rectangle is equal to the length of one side multiplied by the length of the other side.

$$a^2 + b^2 = c^2$$

In a right triangle, the square of one leg's length added to the square of the other leg's length is equal to the square of the hypotenuse's length.

$$C = 2\pi r$$

The distance around a circle (the circumference) is equal to 2 multiplied by π (approximately 3.14) multiplied by the radius of the circle.

In these equations, the variables represent measurements of parts of geometric figures. For example, in the formula $A = L \times W$, the variable A stands for *area*, L stands for *length*, and W stands for *width*. The area of any rectangle can be calculated with this formula, so the variables don't represent specific values. The formula shows the relationship between the area, length, and width of a rectangle.

Formulas can be used to solve problems by finding a missing number. You could substitute any numbers for L and W , multiply the two numbers, and you would get the area of that rectangle. Sometimes, you might have a situation where you know two different measurements and have to figure out the third. For example, you might know the area and the length, but not the width. In that case, you would solve for the missing length.

2) Fill in the missing values in the table.

$$A = L \times W$$

A (area)	L (length)	W (width)
	5 inches	6 inches
24 square feet	8 feet	
36 square inches	4 inches	
100 square yards		yards
	$\frac{1}{2}$ inches	20 inches
500 square miles	25 miles	

Formulas are commonly used in mathematics, science, and other parts of modern life. Later in the packet, we will practice using different formulas.

Variables and Mathematical Properties

Sometimes, variables are used to show how numbers work. For example, look at the equation $a + b = b + a$. You can substitute any number for a and any number for b and this equation will always be true. Here are a few examples:

$$5 + 9 = 9 + 5$$

$$15 + 25 = 25 + 15$$

$$.5 + 2.5 = 2.5 + .5$$

When adding numbers, the order in which you add two quantities doesn't matter. This is called the *commutative property of addition* and can be represented by the equation $a + b = b + a$. In this example, the variables don't represent mystery numbers. In fact, the variables could represent any numbers. The equation is a way of showing how mathematics works in general. In other words, the equation is a *generalization*.

3) Look at the equation $a \cdot b = b \cdot a$, which shows the *commutative property of multiplication*. Explain what this means in your own words. Give a few examples in your explanation.

Expressions, Equations, and Inequalities (Part 2)

Just like addition, multiplication is *commutative*, meaning that order doesn't matter when multiplying numbers. You might try a few examples to prove it to yourself.

We could ask if other operations such as division have the commutative property. In other words, does order matter in division? Let's look at an example.

Is the following equation true? $4 \div 2 = 2 \div 4$

No, the equation is not true. $4 \div 2$ is 2 and $2 \div 4$ is .5. The left side and the right side are not equal, so the equation isn't true. The order of the numbers in division does matter, so division is not commutative.

By the way, you could turn the false equation $4 \div 2 = 2 \div 4$ into a true number sentence by writing $4 \div 2 \neq 2 \div 4$. The symbol \neq means *not equal to*. The number sentence $4 \div 2 \neq 2 \div 4$ is a true statement, but it is not an equation because the two sides aren't equal to each other.

Another common mathematical property shown with variables is $(a + b) + c = a + (b + c)$, which uses parentheses to show the order of operations. This is called the *associative property of addition*. Here are a few examples replacing the variables with numbers:

$$(5 + 9) + 3 = 5 + (9 + 3)$$

$$14 + 3 = 5 + 12$$

$$17 = 17$$

$$(15 + 25) + 30 = 15 + (25 + 30)$$

$$40 + 30 = 15 + 55$$

$$70 = 70$$

- 4) Now, try showing the associative property of addition on your own with $a = 4$, $b = 12$, and $c = 7$. Do the calculation in two different ways to see if you get the same answer.

Expressions, Equations, and Inequalities (Part 2)

The associative property of addition means that if you are adding up numbers, it doesn't matter how you group them. You will still get the same answer. For example, let's say you are adding up sales at the end of a work shift. In order to make it more efficient, you might use a different order when adding the numbers.

- 5) Without writing anything down, find the total of these dollar amounts.

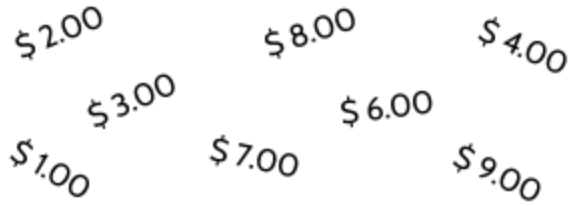

\$2.00 \$8.00 \$4.00
\$3.00 \$6.00
\$1.00 \$7.00 \$9.00

- 6) Try adding up the numbers a few different ways. Do you get the same answer?

You might have noticed that you can add pairs of numbers to make \$10.00. For example, $8 + 2 = 10$, $7 + 3 = 10$, etc. This can help you remember totals when you add up the numbers in your head. If the only operation you are using is addition, you can regroup the numbers in ways that work better for you.

We could ask if other operations have the associative property. Let's start with multiplication. The associative property of multiplication is shown with the following equation:

$$(a \cdot b) \cdot c = a \cdot (b \cdot c).$$

- 7) Here's an example with numbers substituted for a , b , and c . Is it true?

$$(5 \cdot 6) \cdot 3 = 5 \cdot (6 \cdot 3)$$

Expressions, Equations, and Inequalities (Part 2)

8) Complete the table. One box has been done for you.

<i>associative property of multiplication: $(a \cdot b) \cdot c = a \cdot (b \cdot c)$</i>			
Values for a , b , & c	Left Expression	Right Expression	T/F
$a = 5$ $b = 6$ $c = 3$		$5 \cdot (6 \cdot 3)$ $5 \cdot 18$ 90	
$a = 10$ $b = 5$ $c = 4$			
$a = 6$ $b = 8$ $c = \frac{1}{2}$			
Use your own values for a , b , and c .			

9) Do you think subtraction also has an associative property?

Evaluate both sides of the following expression and decide whether the equation is true.

$$(20 - 12) - 6 = 20 - (12 - 6)$$

Expressions, Equations, and Inequalities (Part 2)

The equation $a \cdot (b + c) = a \cdot b + a \cdot c$ shows the *distributive property of multiplication*, which we used when multiplying with rectangles in Part I. This property is often used in algebra to solve equations or identify when expressions are equivalent. We used rectangles like the one below to show that because of the distributive property, $4 \cdot (10 + 5)$ is equal to $4 \cdot 10 + 4 \cdot 5$.

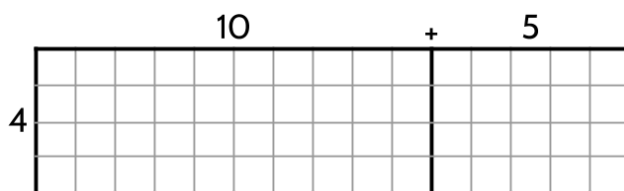

$$4 \cdot (10 + 5) = (4 \cdot 10) + (4 \cdot 5)$$

$$4 \cdot 15 = 40 + 20$$

$$60 = 60$$

By the way, it isn't important to remember the names of these properties. It is useful, however, to understand each of them..

Expressions, Equations, and Inequalities (Part 2)

10) Complete the table by writing explanations for each of the equations on the left.
(Try substituting numbers for the variables. Does the equation stay balanced when you substitute different numbers for the variables?)

Equation	Explanation
$a + b = b + a$	It doesn't matter what order you add two numbers. For example: $5 + 12 = 12 + 5$.
$a \cdot b = b \cdot a$	
$(a + b) + c = a + (b + c)$	
$(a \cdot b) \cdot c = a \cdot (b \cdot c)$	
$a \cdot (b + c) = a \cdot b + a \cdot c$	

Variables in Inequalities

A variable can also be used in a number sentence to represent a group of numbers. What if we want to refer to all the numbers less than 10? You use a variable and the less than symbol to write this as an expression:

$$w < 10$$

You can read this expression as:

“ w is less than 10”

This is called an inequality. In this example, the variable w isn't a single number and it can't be just any number. Any number less than 10 would make this inequality true.

11) Which expression represents all numbers greater than 25?

A. $x < 25$

B. $x > 25$

C. $x = 25$

We can use variables in inequalities to describe situations mathematically. Imagine that you are organizing a kid's 7th birthday party and want to invite children that are older than 4, but younger than 10. If y represents the age of the kids invited to the party, you write the following expression:

$$4 < y < 10$$

You can read this expression as:

“ y is greater than 4 and less than 10”

12) Which expression is the same as “ z is greater than 20 and less than 30”?

A. $20 < z < 30$

B. $30 < z < 20$

C. $20 > z > 30$

We will do more practice with inequalities later in the packet.

Expressions and Equations II

Another Magic Trick

- 1) We're going to learn another math magic trick. You will probably want to use a calculator for this.

Take the number formed by the first 3 digits of your phone number (not including area code) and multiply it by 40. Add 1 to the result. Multiply by 500. Add the number formed by the last 4 digits of your phone number, and then add it again. Subtract 500. Divide by 2.



Try out the calculations. You may have to do the calculations a few times before you see the magic. Show your work below:

What is the final number?

Later in the packet, we will use algebra to analyze this math magic trick. In the meantime, try it with your friends and family. See if you can figure out how it works.

Tape Diagrams¹

These visual models are a tool for setting up algebraic equations based on word problems and real-life situations. You can make your own tape diagrams as a way to understand problems and find solutions.

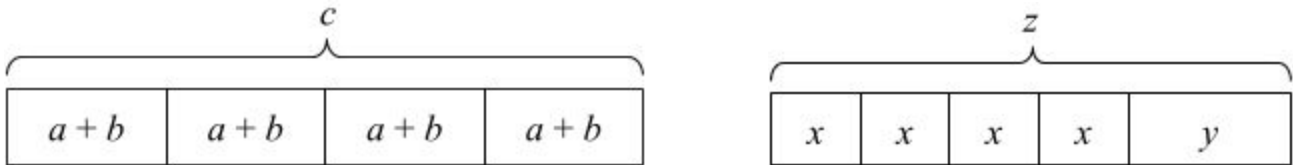

- 2) Choose a few numbers that c could represent. For each c you try, what would a and b represent?

c	a	b

- 3) What are some possible values for x , y , and z in the second diagram? How do you know these values would work?

¹ Many of these activities are adapted from Open Up Resources. More study materials like this are available for free at <https://openupresources.org>.

Expressions, Equations, and Inequalities (Part 2)

For each story and tape diagram below, write an explanation and label each part of the tape diagram.

- 4) Erica is organizing a community event. She made 50 flyers for five volunteers in her neighborhood organization to hang up around their homes. She gave 5 flyers to the first volunteer, 18 flyers to the second volunteer, and divided the remaining flyers equally among the three remaining volunteers.

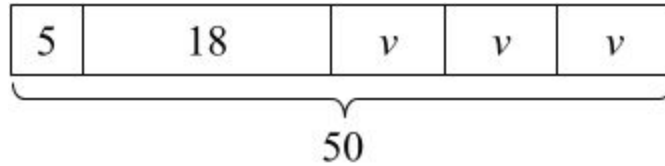

- 5) To thank her five volunteers, Erica gave each of them the same number of stickers. Then she gave them each two more stickers. Altogether, she gave them a total of 30 stickers.

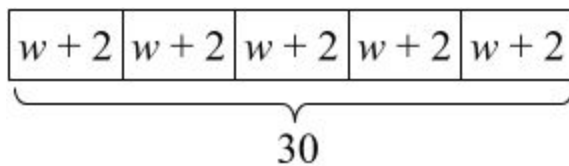

Expressions, Equations, and Inequalities (Part 2)

Here are three more stories. Draw a tape diagram to represent each story. Then describe how you would find any unknown amounts in the stories.

- 6) Maureen and her sister are making gift bags for a birthday party. Maureen puts 3 pencil erasers in each bag. Her sister puts stickers in each bag. After filling 4 bags, they have used a total of 44 items.

- 7) Maureen's family also wants to blow up a total of 60 balloons for the party. Yesterday they blew up 24 balloons. Today they want to split the remaining balloons equally between four family members.

- 8) Maureen's family bought some fruit bars to put in the gift bags. They bought one box each of five flavors: apple, strawberry, blueberry, cherry, and peach. The boxes all had the same number of bars. Maureen wanted to taste the flavors and ate one bar from each box. There were 25 bars left for the gift bags.

Expressions, Equations, and Inequalities (Part 2)

9) Shalisa bought 4 bags of apples. Each bag had the same number of apples. After eating 1 apple from each bag, she had 28 apples left.

- Which diagram best represents the story? Explain why the diagram represents it.

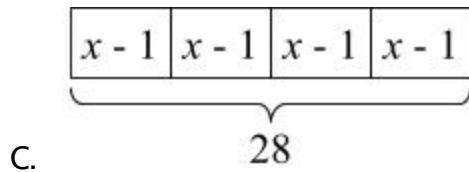
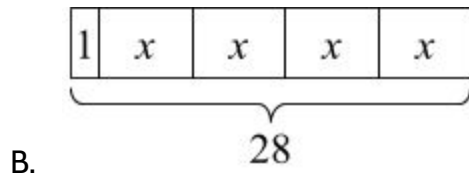
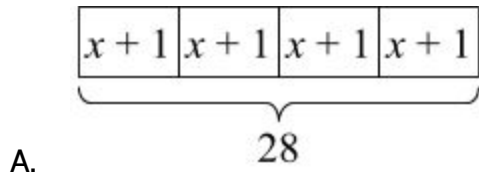

- What part of the story does x represent?
- Describe how you would find the unknown amount in the story.

10) Select all the equations that match the tape diagram.

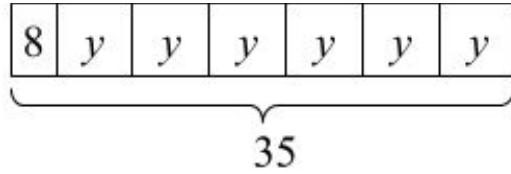

- A. $35 = 8 + y + y + y + y + y + y$
- B. $35 = 8 + 6y$
- C. $6 + 8y = 35$
- D. $6y + 8 = 35$
- E. $6y + 8 = 35y$
- F. $35 - 8 = 6y$

11) Select all stories that the tape diagram can represent.

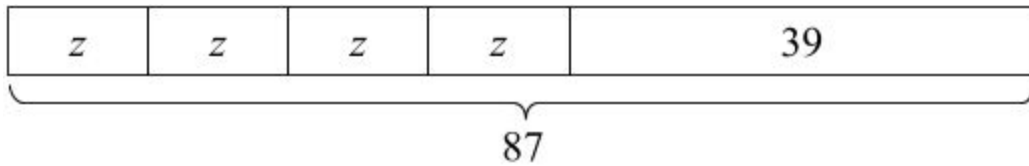

- A. There are 87 children and 39 adults at a show. The seating in the theater is split into 4 equal sections.
- B. There are 87 first graders in afterschool programs. After 39 students are picked up, the teacher put the remaining students into 4 groups for an activity.
- C. Lin buys a pack of 87 pencils. She gives 39 to her teacher and shared the remaining pencils between herself and 3 friends.
- D. Andre buys 4 packs of paper clips with 39 paper clips in each. Then he gives 87 paper clips to his teacher.
- E. Diego's family spends \$87 on 4 tickets to the fair and a \$39 dinner.

12) Write a story that matches this diagram.

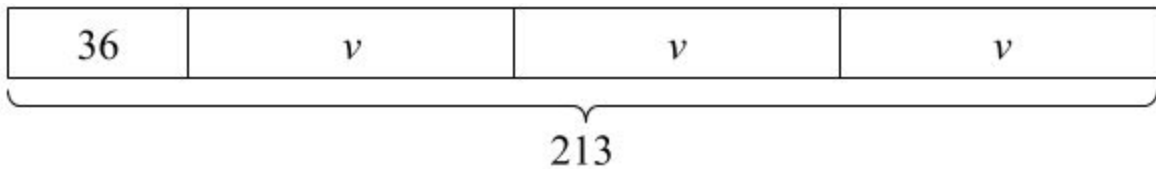

13) We can use tape diagrams to show that two expressions are equivalent by using bars that are the same length.

What story do you think this pair of tape diagrams could represent?

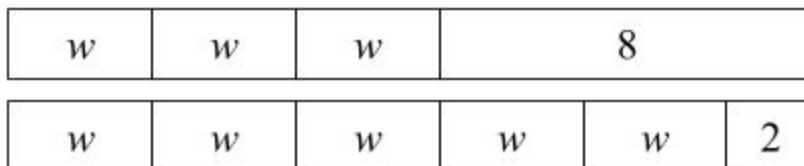

14) What value for w above makes the two bars equal in length?

Expressions, Equations, and Inequalities (Part 2)

15) Draw a tape diagram to match each equation.

$$114 = 3x + 18$$

$$114 = 3(y + 18)$$

16) Use any method to find values for x and y that make the equations in the previous question true.

17) Find a solution to each equation without writing anything down.

$$v + 1 = 5$$

$$v =$$

$$2(w + 1) = 10$$

$$w =$$

$$3(x + 1) = 15$$

$$x =$$

$$500 = 100(y + 1)$$

$$y =$$

Like Terms

- 18) Evaluate the following expression for $x = 5$. You may want to use a calculator. Keep track of your work below.

$$3x + 5 + 2x^2 - 3 + 8x + x^2 - 11x + 5x - 3x^2 + 4 - 3x - 6 - 2x + x^2$$

Expressions, Equations, and Inequalities (Part 2)

Evaluating the expression on the last page was a pain, wasn't it? In case you were wondering, there is a way to approach this problem that makes it much simpler to deal with. The strategy involves a step you can take before substituting 5 for all the x 's. Is there anything you could do to simplify the expression before starting your calculations?

Let's look at some simpler examples to build up some strategies.

Multiplication is Repeated Addition

We'll start by thinking about multiplication. You can think of multiplication as a way to do addition multiple times. For example, $5 + 5 + 5 + 5 + 5 + 5 + 5$ is equivalent to 7×5 . So, the multiplication of 7×5 means the same thing as seven 5's. In other words, "seven times five" is equal to "five, seven times."

As a reminder, you can write "seven times five" in many different ways:

7×5

$7 \cdot 5$

$7 * 5$

$(7)(5)$

First, we'll practice turning multiplication into addition.

19) Complete this table.

written as multiplication	written as repeated addition	value
3×5	$5 + 5 + 5$	15
$4 * 9$	$9 + 9 + 9 + 9$	
$(3)(8)$		
$7 \cdot v$		$7v$

Can you answer this question without doing any calculations?

20) Is $8 \cdot 6$ equivalent to $5 \cdot 6 + 3 \cdot 6$? Why or why not?

Expressions, Equations, and Inequalities (Part 2)

To determine if $8 \cdot 6$ is equivalent to $5 \cdot 6 + 3 \cdot 6$, you could calculate the value of both expressions to see if they are equal, but we're trying to do this without calculations. To see if they are equivalent without actually doing the calculation, think about what each expression means:

$$8 \cdot 6 = 6 + 6 + 6 + 6 + 6 + 6 + 6 + 6 \rightarrow \text{eight 6's}$$

$$5 \cdot 6 + 3 \cdot 6 = (6 + 6 + 6 + 6 + 6) + (6 + 6 + 6) \rightarrow \text{five 6's and three 6's}$$

We can see that both expressions add up eight 6's, which is 48. Five 6's added to three 6's equals eight 6's. Here's another way to see it:

$$(8)(6) = (5)(6) + (3)(6)$$

So, eight 6's is equal to eight 6's and the two expressions are equivalent. In the equation above, we are able to add the **5** to the **3** to get **8** 6's.

Now, let's look at a similar situation using variables.

21) Is $7 \cdot w$ equivalent to $4 \cdot w + 3 \cdot w$? Why or why not?

To determine if $7 \cdot w$ equivalent to $4 \cdot w + 3 \cdot w$, we can think about what each expression means:

$$7 \cdot w = w + w + w + w + w + w + w \rightarrow \text{seven } w\text{'s}$$

$$4 \cdot w + 3 \cdot w = (w + w + w + w) + (w + w + w) \rightarrow \text{four } w\text{'s and three } w\text{'s}$$

Both expressions add up to seven w 's. Four w 's plus three w 's equals seven w 's. In other words, we can *simplify* $4w + 3w$ to $7w$. You will simplify more expressions on the next page.

We also know that these two equations...

$$8 \cdot 6 = 5 \cdot 6 + 3 \cdot 6 \text{ and } 7 \cdot w = 4 \cdot w + 3 \cdot w$$

... are true because of the distributive property:

$$8 \cdot 6 = 5 \cdot 6 + 3 \cdot 6 \text{ and } 7 \cdot w = 4 \cdot w + 3 \cdot w$$

$$8 \cdot 6 = 6(5 + 3) \text{ and } 7 \cdot w = w(4 + 3)$$

... and the commutative property: $8 \cdot 6 = 6 \cdot 8$ and $7 \cdot w = w \cdot 7$

Expressions, Equations, and Inequalities (Part 2)

Simplify the following expressions.

22) $4x + 8x + x$

23) $7v + 4w + 3v + 6w$

Check your understanding: Do you think $6x + 4x + 2x$ equivalent to $7x + 3x + 2$?

In order to see if $6x + 4x + 2x$ equivalent to $7x + 3x + 2$, let's think about what each expression means. $6x$, $4x$, $2x$, $7x$, and $3x$ are groups of x 's. The number 2 is standing on its own.

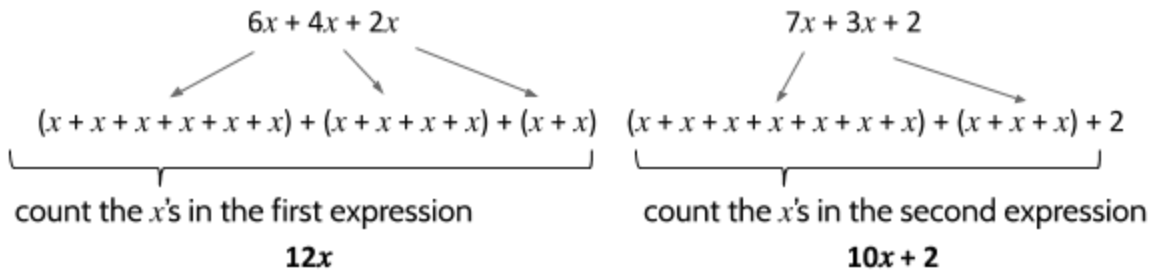

We can't add $10x$ to 2 because they are two different kinds of quantities. $10x$ means ten x 's. 2 just means 2. It doesn't mean two x 's.

24) We could also evaluate the two simplified expressions with a table. Fill in the blanks.

	$12x$		$10x + 2$		
x	Substitute for x	Value of expression	Substitute for x	Value of expression	Equivalent?
1	$12(1)$		$10(1) + 2$		
2	$12(2)$		$10(2) + 2$		
3					
4					

Since $12x$ is equal to $10x + 2$ for only one value of x , we can determine that the expressions are not equivalent.

25) Are $3w + 7 + 5w + 5$ and $3 + 7w + 5 + 5w$ equivalent expressions? Why or why not?

Expressions, Equations, and Inequalities (Part 2)

State whether the equation is true or false. If it is true, explain why it is true. If it is false, rewrite the equation to make it true.

26) $25x - 9x = 16x$ True. Twenty-five x 's minus nine x 's is sixteen x 's.

27) $6x - x = 5$

28) $.5(4x + 8) + 3x = .5 + 5x + 3.5$

29) $10 - 2x = 8x$

30) $7 + 3(x + 2) = 10(x + 2)$

Combining like terms

In the expressions $12x$ and $10x + 2$, the numbers 12 and 10 are called *coefficients*. A coefficient is a number that is multiplied by a variable. The coefficients 12 and 10 tell us the number of x 's in each expression. The coefficient is the first number in each of the following expressions:

$7v$

$2.5a$

$\frac{1}{2}y$

$4w^2$

$5z^3$

A coefficient and variable together are considered a term. This is true even if the variable is raised to a power. The coefficient, the variable, and the power together are considered a term.

$$5x + 2y + 6x + 3x^2 + 12 + 4y^3 + 5 + z + 2x^2$$

↑↑↑↑↑
terms

If the terms are alike, such as $5x$ and $6x$, they can be combined. Five x 's and six x 's make eleven x 's (also known as $11x$). The term 5 can also be added to 12 since they are both plain numbers.

31) Do you see any other terms in the expression above that can be combined?

Expressions, Equations, and Inequalities (Part 2)

The last two terms that can be combined are $3x^2$ and $2x^2$. Three x^2 's and two x^2 's are five x^2 's (or $5x^2$).

Here is another way to look at all the terms from the expression above:

$$\begin{array}{ll} 12 + 5 & 2y \\ 5x + 6x & 4y^3 \\ 3x^2 + 2x^2 & z \end{array}$$

The numbers 12 and 5 are *like terms*, because they are the same kind of term (a plain number). $5x$ and $6x$ are also like terms, since they are both groups of x 's, so they can be combined. $3x^2$ and $2x^2$ are the final pair of like terms.

When you look at the terms above, you may notice there is only one y term, one y^3 term, and one z term. There aren't any other like terms for them to be combined with. These terms cannot be combined with any other terms in the expression.

Here is the expression from the previous page, simplified with the like terms combined:

$$4^3 + 5^2 + 11x + 2y + z + 17$$

For two terms to be considered alike, they must have the same variable and the same exponent applied to the variable. For example, $10b$ and $15b$ are *like terms* and can be combined to make $25b$. However, the terms $8v$ and $7v^2$ are *unlike terms* and cannot be combined to make $15v$ or $15v^2$ since v and v^2 are not the same.

The four expressions below each have three terms. Rewrite each expression using fewer terms. Show your work or explain your reasoning.

32) $10w - 2w + 5$

34) $5z^2 + 2.5z^2 - 2.5$

33) $10x - 3y + 2x$

35) $5v + 2.5v^2 - 2$

Expressions, Equations, and Inequalities (Part 2)

- 36) At the beginning of this section, you were asked to find the value of the expression below for $x = 5$. Try it again, this time using all you have learned about combining like terms.

$$3x + 5 + 2x^2 - 3 + 8x + x^2 - 11x + 5x - 3x^2 + 4 - 3x - 6 - 2x + x^2$$

Algebra By Example²

These problems are designed to help you learn from math mistakes. The questions are based on common algebra mistakes many people make. Understanding the way other people have done the math will help you better understand the math yourself. Analyzing common mistakes will help you recognize them in your own work.

37) Write the following expressions in **simplest form**. Show your work.

Elizabeth tried to simplify this expression, but she **didn't** do it correctly.

$$5x - x + 2$$

$$5x - x + 2$$

$$5 + 2$$

$$7$$

What did Elizabeth do wrong in her first step?

Would it have been okay to add $4x + 2$? Explain why or why not.

Your Turn:

$$10x - x + 6$$

Simplify the expression below.

² These are adapted from SERP AlgebraByExample materials, which can be found at <http://math.serpmedia.org>.

38) Write the following expressions in **simplest form**. Show your work.

Lacey simplified this expression **correctly**.

$$5x + 2 - 3x + 20x^2$$

$$5x + 2 - 3x + 20x^2$$

$$2 + 2x + 20x^2$$

Why didn't Lacey combine $2x$ and $20x^2$?

Your Turn:

$$3x + 9 - 6x^2 - 5$$

39) Using the distributive property, rewrite the expression in **simplest form**. Show your work.

Liz wrote this expression **correctly**. Here is what she wrote:.

$$5(8 + 12)$$

$$5(8 + 12)$$

$$5 \times 8 + 5 \times 12$$

$$40 + 60$$

$$100$$

Why was it important for Liz to multiply the 5 by both the 8 and the 12 ?

What common mistake might result in an incorrect answer of 52 ?

Your Turn:

$$4(12 - 5)$$

- 40) Write an expression or equation to represent the situation. You do **not** need to solve any equations.

Simone wrote an equation **correctly** after reading the following situation.

Bonita got her paycheck of \$480 this week. She had \$20 left after she spent m dollars on school clothes. How much did the school clothes cost?

$$480 - m = 20$$

How did Simone know that this was an equation and not an expression?

Why subtract m from 480 rather than add m to 480?

Your Turn:

The Zhang family is moving today. It took 30 boxes to pack all of their children's possessions. Mr. Zhang put 3 boxes in the truck. How many boxes, b , still need to be put into the truck?

Write an equation to represent the situation.

- 41) Write an expression or equation to represent the situation. You do not need to solve any equations.

Lucy **didn't** write this equation correctly. Here is what she wrote:

Jacintha is 6 inches shorter than two times her cousin's height, c . How tall is Jacintha?

$$6 - 2c$$

To see what Lucy did wrong, consider that c is 40 inches. How tall would Jacintha be?

Is $6 - 80$ the same as $80 - 6$? Explain why or why not.

Your Turn:

There are 6 members in Patrick's chorus. They made 95 copies of their new album and each member sold x copies. Assuming every member sold the same number of copies, how many albums does the chorus have left?

Write an equation to represent the situation.

- 42) Write an expression or equation to represent the situation. You do not need to solve any equations.

Carthian **didn't** write this equation correctly. Here is what she wrote:

Three siblings baked b brownies together this weekend. They threw away 24 brownies that burned and split the rest evenly, each taking home 10 brownies. How many cookies did they bake?

$$b - 24 = 10$$

What information from the word problem did Carthian forget to include in her equation?

What should the equation look like?

Your Turn:

The sales team at Vesto Sports made \$500 in commission this week. All 5 members each received \$80 and put the rest in the holiday dinner party fund. How much total money did they put in the holiday dinner party fund?

Write an equation to represent the situation.

- 43) Write an expression or equation to represent the situation. You do not need to solve any equations.

Erica wrote an equation **correctly**. Here is what she wrote:

Mauricio works as a server in a restaurant and made \$80 in tips each night he worked this week. He spent \$30 on gas and had \$370 left for himself. How many days did he work this week?

$$80x - 30 = 370$$

What does x stand for in Erica's equation?

Why is she correct to subtract 30 rather than add 30?

Your Turn:

Latiffah planted 22 vegetables in her garden. She planted an equal number of three types of tomatoes, as well as 7 bean plants. How many of each type of tomatoes did Latiffah plant?

Write an equation to represent the situation.

The Math Behind the Magic Trick II

At the beginning of this section, we practiced the following math trick.

Take the number formed by the first 3 digits of your phone number (not including area code) and multiply it by 40. Add 1 to the result. Multiply by 500. Add the number formed by the last 4 digits of your phone number, and then add it again. Subtract 500. Divide by 2.

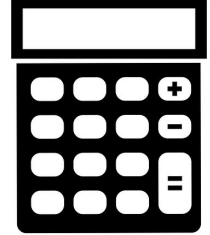

Did you notice that the final answer is your phone number?!

Let's try applying some of the tools of algebra to see how the trick works. Since we don't know what telephone number people will have, we will use variables. We will need one variable for the first three digits of the telephone number and another variable for the last four digits. Let's use a for the first three digits and b for the last four digits.

We can build up an equation by following the steps of the trick and turning it into math language as we go:

First three digits →	a
Multiply the number by 40 →	$40a$
Add 1 →	$40a + 1$
Multiply by 500 →	$500(40a + 1)$
Add the last four digits →	$500(40a + 1) + b$
Add the last four digits again →	$500(40a + 1) + b + b$
Subtract 500 →	$500(40a + 1) + 2b - 500$
Divide by 2 →	$\frac{500(40a + 1) + 2b - 500}{2}$

The expression $\frac{500(40a + 1) + 2b - 500}{2}$ means:

Multiply a number by 40, then add 1, then multiply by 500, then add another number twice, then subtract 500, then divide the result by 2.

Expressions, Equations, and Inequalities (Part 2)

- 44) What is the value of $\frac{500(40a + 1) + 2b - 500}{2}$ if $a = 867$ and $b = 5309$?
- 45) Simplify the expression $\frac{500(40a + 1) + 2b - 500}{2}$ so that it has fewer terms. Reduce the number of terms as much as possible. Show your work below.
- 46) Which of these expressions is not equivalent to $\frac{500(40a + 1) + 2b - 500}{2}$?
- A. $\frac{20,000a + 500 + 2b - 500}{2}$
- B. $\frac{20,000a + 2b}{2}$
- C. $10,000a + 2b$
- D. $10,000a + b$
- 47) Rose took the following steps to simplify the expression $100(30c + 4) - 500d + 50$.
- | | |
|-----------|----------------------------|
| Equation: | $100(30c + 4) - 500d + 50$ |
| Step 1: | $3000c + 400 - 500d + 50$ |
| Step 2: | $3000c + 450 - 500d$ |
| Step 3: | $3450c - 500d$ |
- In which step, if any, did Rose make an error?
- A. Step 1
- B. Step 2
- C. Step 3
- D. Rose did not make an error.

Solving Equations

Area Models for Multiplication II

In Part 1 of **Expressions, Equations, and Inequalities**, we used area models to create expressions and equations using multiplication. For example, we could use the following area model to think about the expression 7×13 .

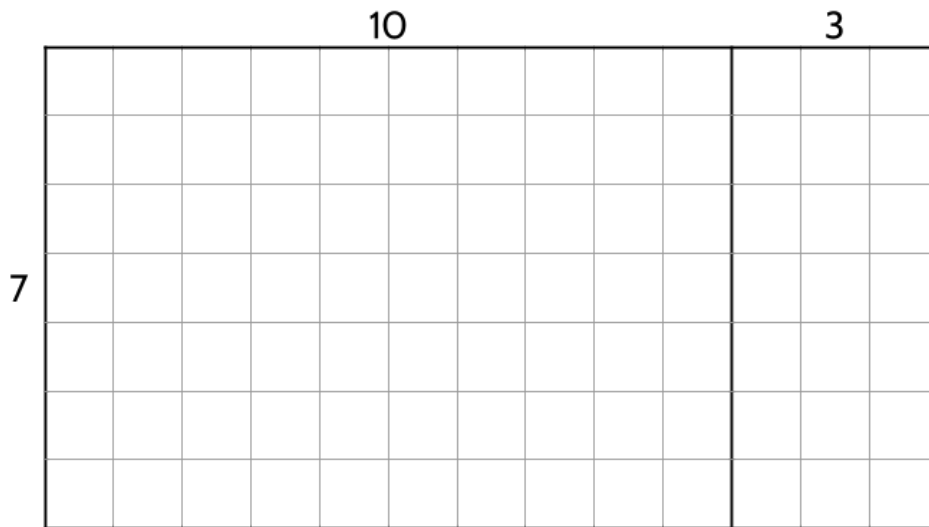

The area model shows 7×13 as a rectangle. The area of the rectangle is the product of 7 and 13. To find the area of the large rectangle, we split it into two smaller rectangles and then found the area of each of those. Then we added the area of the two small rectangles to find the area of the large rectangle.

Here are a few ways of calculating the area of the large rectangle:

$$7 \cdot 10 + 7 \cdot 3$$

$$70 + 21$$

$$91 \text{ squares}$$

$$7(10 + 3)$$

$$70 + 21$$

$$91 \text{ squares}$$

$$7 \cdot 13$$

$$91 \text{ squares}$$

Expressions, Equations, and Inequalities (Part 2)

In the area model examples so far, we knew the length of the sides of the rectangle and used the side lengths to find the area. What if we knew the area of the rectangle, but only knew one of the side lengths? Could we find the other side length? What if other side lengths were missing?

- 1) What is the length of the missing side of this rectangle?

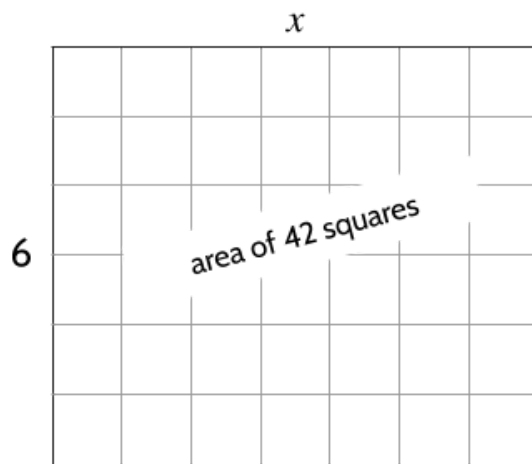

Equation:

$$6 \cdot x = 42$$

$$x = \underline{\hspace{2cm}}$$

The area model above could be represented with the equation $6 \cdot x = 42$, meaning some number multiplied by 6 is equal to 42.

The example above shows that we can find one length of a rectangle if we know the other length and the area.

What if we knew the area, the length of one side of the rectangle and part of the length of the other? Could we find the missing part of the length?

- 2) Can you figure out the length of x ?

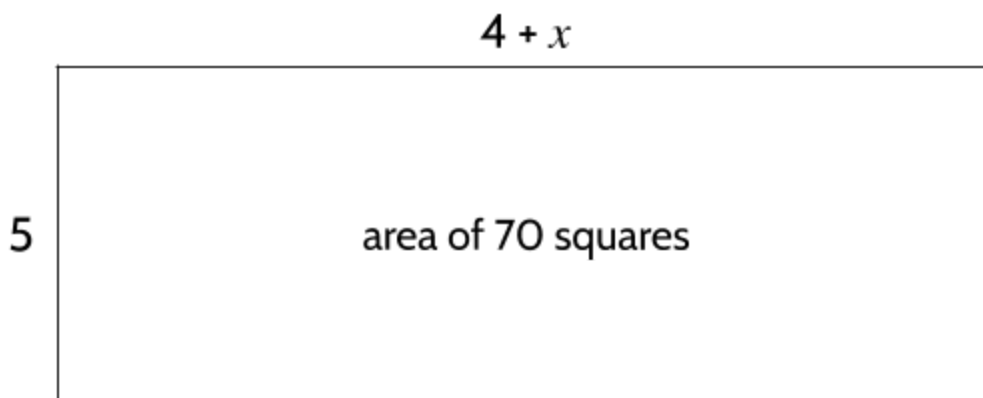

The area of this rectangle could be represented with the equation $5(4 + x) = 70$.

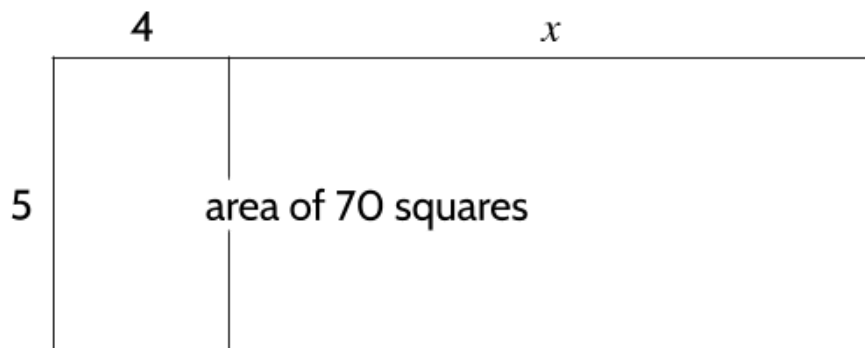

Let's start with a visual way to find the length of x . We can split the large rectangle into two smaller rectangles. We know the size of the small rectangle on the left. It is 5 units tall and 4 units wide, so it must be 20 square units in area.

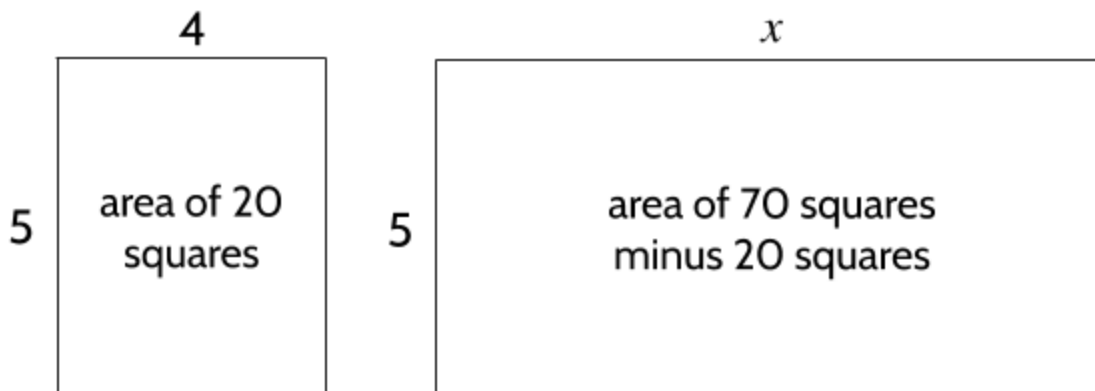

This helps us see that the rectangle on the right has an area of 70 squares minus the 20 squares in the left rectangle. We could write an equation for the right rectangle:

$$5x = 70 - 20$$

- 3) What is the length of x ?

Expressions, Equations, and Inequalities (Part 2)

We could also find the length of x with an algebraic method and the distributive property of multiplication. Earlier in the packet, we reviewed the distributive property. Here's an example which uses the distributive property with a different equation:

$$4 \cdot (10 + 5) = 4 \cdot 10 + 4 \cdot 5$$

Here is our equation, with x representing a missing part of the length of the rectangle:

$$5(x + 4) = 70$$

- 4) Using the distributive property, which of the following equations are equivalent to $5(x + 4) = 70$?
- A. $5x + 4 = 70$
 - B. $5x + 20 = 70$
 - C. $x + 20 = 70$
 - D. $x + 4 = 70$
- 5) Using the correct equation above, solve for x . Show your work.

Confirm your answer is correct by counting boxes along the top edge of the rectangle.

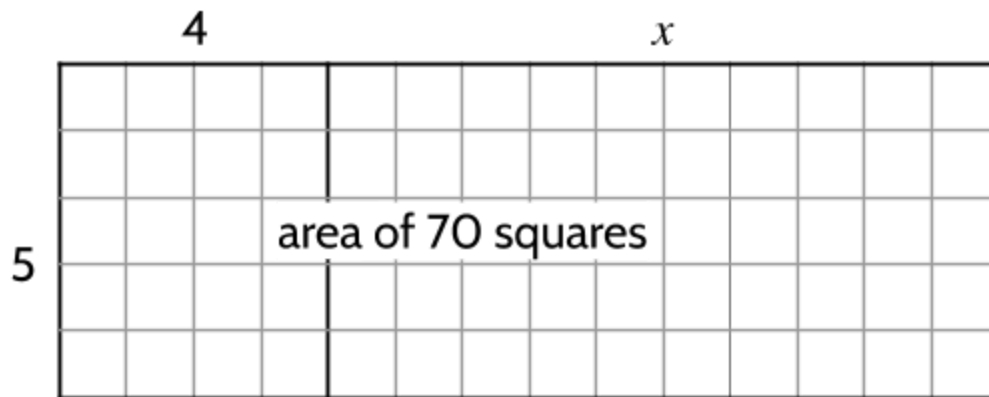

Expressions, Equations, and Inequalities (Part 2)

- 6) Find the length of v in the rectangle below. You can use a visual way of finding the length, an algebraic way, or another way that works for you. Show your work.

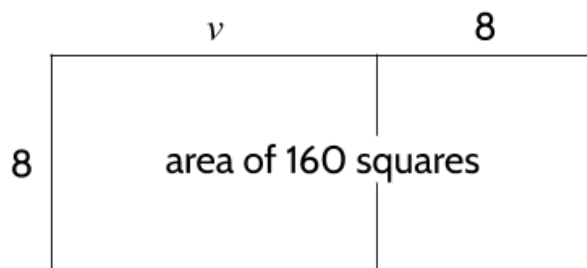

- 7) Find the length of w in the rectangle below. Use any method you like.

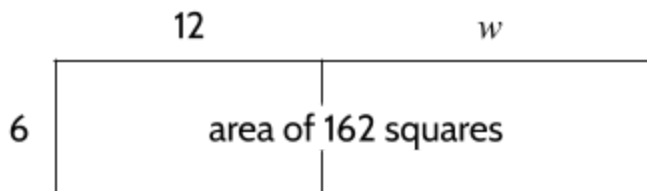

- 8) Solve $9(x + 5) = 225$ for x . Draw a picture if it helps.

- 9) What value of y is a solution for $20(y + 15) = 900$?

Guess My Number II

I have some mystery numbers in my head. I am going to give you some hints about my number. Your challenge is to figure out the mystery number in each description. Use n as a variable to stand for *number*.

- 10) a number, multiply it by 2 then add 1 and the result is 11

$$2n + 1 = 11$$

$$2n = 10$$

$$n = 5$$

- 13) a number, add 3 then multiply by 2 and the result is 20

- 11) a number, multiply it by 5 then add 6 and the result is 26

- 14) a number, take away 2 then divide by 4 and the result is 3

- 12) a number, half it, then take away 4 and the result is 11

- 15) a number, multiply by 3, then add 2 and then divide by 4 and the result is 5

Expressions, Equations, and Inequalities (Part 2)

16) a number, add 2, multiply by 3,
divide by 5 and the result is 9

19) start with 4, square it, add 11, and
divide by 3 to get a number

17) a number, divide by 3, add 4,
multiply by 2 and the result is 20

20) start with 7, add 9, take the square
root, subtract 2, and divide by 2 to
get a number

18) a number, multiply by 3, add 2,
divide by 2, subtract 1 and the result
is 3

21) a number, multiply by 2, divide by
5, add 7, multiply by 4 and the
result is 44

Simplify and Solve

For each of the following equations, simplify the expressions on both sides by using the distributive property and combining like terms, then solve for the value of the variable that keeps the equation balanced.

22) $3(4v + 10) = 2(4v + 21)$

23) $5(3w - 2) + 8 = 2(3w + 1) + 2$

A. $\frac{2}{3}$

B. $\frac{3}{2}$

C. $\frac{2}{8}$

D. $\frac{2}{5}$

24) $16x + 4(5 - 2x) = 6x + 28$

A. 2

B. 4

C. 6

D. 8

25) Which of these is equivalent to the expression $3(2x + 3) + \frac{1}{3}(9x + 6)$?

A. $9x + 9$

B. $9x + 11$

C. $11x + 9$

D. $33x + 30$

Creating and Solving Equations III

- 26) Directions: Use only the digits 1 to 9 in each box, at most one time each, to create an equation where x has the greatest possible value.

$$\boxed{}x - \boxed{} = \boxed{}$$

Solve each of your equations. Feel free to use a calculator.

$$\boxed{3}x - \boxed{4} = \boxed{2}$$

Solved: $x = 2$

Can you create an equation with a larger value for x ?

Solving for Variables

Write each of these statements as equations and then solve for the first variable. (This means that the first variable should be by itself on one side of the equation at the end.)

- 27) a number *area*, divide by *length*
and the result is *width*

$$\frac{\text{area}}{\text{length}} = \text{width}$$

$$\frac{\text{area}}{\text{length}} \cdot \text{length} = \text{width} \cdot \text{length}$$

$$\text{area} = \text{width} \cdot \text{length}$$

- 29) a number *mass*, divide by *density*
and the result is *volume*

- 28) a number *d*, divide by *t* and get *r*

- 30) a number *density*, multiply by *area*
and the result is *population*

- 31) a number *C*, divide by 2π and the
result is *r*

- 32) a number *V*, multiply it by 3,
divide by *h*, and the result is *B*

- 33) a number *F*, subtract 32, divide by
9, multiply by 5 and the result is *C*

- 34) a number *b*, square it, divide by
 $5 + 4$, add 4 and the result is 5

Using Formulas

At the beginning of this packet, we looked at how variables are used in a few common formulas in geometry, such as the area of a rectangle and the circumference of a circle. The variables in these formulas show relationships that are true for rectangles and circles of any size. Formulas can be used to make calculations and find answers to common questions.

Formulas are used in many different subjects. In geometry, $a^2 + b^2 = c^2$ is a formula for finding side lengths of a right triangle. In science, $density = \frac{mass}{volume}$ is a formula for finding the density of matter. When traveling, the formula $distance = rate \times time$ can be used to see how far you will go in a certain amount of time.

Distance, Rate and Time

A formula for speed looks like this:

$$r = \frac{d}{t}$$

where r is speed (rate), d is distance, and t is time.

Speed is an example of a *rate* that compares two related quantities: distance traveled and the amount of time that has gone by. Density is another example of a rate. The density of matter compares the amount of mass with the amount of volume. Population density compares the number of people with the amount of space.

Here's an example of a situation where you could use the formula for speed.

Ismael drove 130 miles in 2 hours. What was his average speed?

The answer to the question is not just a number. The answer is a rate, "65 miles per hour," which is the same thing as saying, "65 miles for each 1 hour." For each 1 hour that passed, the car traveled 65 miles.

Expressions, Equations, and Inequalities (Part 2)

1) Complete the following table.

Mode of Travel	Distance d (miles)	Time t (hours)	Rate r (miles per hour)
Car	130	2	65
Car	150	5	
Bike	22.5	2.5	
Walking	7.5		3
Boat	8	.5	
Plane	1750	3.5	

2) The formula for speed can be manipulated in order to solve for different variables. Check each of the equations below to see if they are true.

A. $16 \text{ miles per hour} = \frac{8 \text{ miles}}{.5 \text{ hours}}$

True. $8 \div .5$ is 16.

B. $16 \text{ miles per hour} \times .5 \text{ hours} = 8 \text{ miles}$

C. $16 \text{ miles per hour} = .5 \text{ hours} \times 8 \text{ miles}$

D. $.5 \text{ hours} = \frac{8 \text{ miles}}{16 \text{ miles per hour}}$

3) Write a letter next to each version of the speed formula below to match with the true equations above.

 D $time = \frac{distance}{rate}$

 $distance = rate \cdot time$

 $rate = \frac{distance}{time}$

Expressions, Equations, and Inequalities (Part 2)

Consider the formula $d = rt$.

- 4) If the speed, r , is doubled and time of travel stays the same, what happens to the distance traveled?
 - A. The distance traveled also doubles.
 - B. The distance traveled stays the same.
 - C. The distance traveled is cut in half.
 - D. The distance traveled is tripled.

- 5) If the time is reduced by half and the speed stays constant, what happens to the distance traveled?

- 6) Challenge question: The speed of light is 671,000,000 miles per hour (also written as 6.71×10^8). It takes about 4 hours for light from the Sun to get to Neptune, the farthest planet from the Sun. How far is Neptune from the Sun?



The Italian physicist Galileo Galilei (1564-1642) is usually credited with being the first person to measure speed by considering the distance traveled and the time it takes. He also studied astronomy and argued that the Earth revolves around the sun. Galileo defined speed as the distance traveled per unit of time.

Force, Mass and Acceleration

Sir Isaac Newton (1643-1727) was an English mathematician, physicist, and astronomer. He used three laws of motion to explain how objects move. These physical laws, along with the law of universal gravitation³, which he also developed, explained much of what scientists observed in his lifetime.

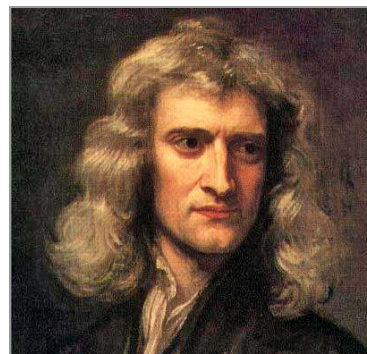

If you study physics, these ideas are some of the first things you will study.

Newton's Laws of Motion:

1. Every object moves in a straight line unless acted upon by a force.
2. The acceleration of an object is proportional to the force applied to it and inversely proportional to the object's mass.
3. For every action, there is an equal and opposite reaction.

We are going to look closely at Newton's 2nd Law of Motion. Let's start by defining a few words.

Acceleration is a change in speed. A ball rolling down a hill accelerates as it goes, meaning it goes faster and faster the longer it rolls. The speed of the ball increases.

Proportional means that two quantities are related so that if one quantity increases, the other quantity increases as well. In the formula $d = rt$, distance and time have a proportional relationship. If the time is increased, the distance increases, and the object travels farther. If the distance is increased, it takes longer to travel that distance.

Inversely proportional means that two quantities are related so that if one quantity increases, the other quantity decreases. In the formula $r = \frac{d}{t}$, speed and time have an inversely proportional relationship. If the speed is increased, it will take less time to travel the same distance. If the time is increased, it will require less speed to travel the same distance.

³ Newton's law of gravity explains how large objects, such as the Moon, Earth, and the Sun, have strong gravitational forces, but also shows that smaller objects like people and buildings have their own (very small) gravitational force that draws physical objects towards them. The gravitational force we have for other objects is incredibly small, but can be calculated using Newton's formulas.



Newton's 2nd Law: The acceleration of an object is proportional to the force applied to it and inversely proportional to the object's mass.

Because of the second law of motion, a couple things are true:

- An object will increase its acceleration if more force is applied to it. For example, in the photo above, if more dogs pull the sled, the sled will increase in speed faster than if it had fewer dogs.
- An object will decrease its acceleration if the mass increases. For example, if more luggage is added to the sled, the acceleration will go down.

The following formula is used to express the relationship Newton discovered between acceleration, force, and mass:

$$\text{force} = \text{mass} \times \text{acceleration}$$

Or abbreviated as

$$f = ma$$

Force is a measure of how much energy is used to push or pull something. It is usually measured in *newtons*, which are equal to $kg \cdot m/s^2$ (kilogram-meters per second squared) and are usually abbreviated as N. This unit of measurement is named after Isaac Newton.

Mass basically refers to the weight of an object. It is usually measured in *kg* (kilograms). There are about 2.2 pounds in 1 kilogram.

Acceleration is usually measured in m/s^2 (meters per second squared). This is a measure of how much an object speeds up or slows down.

Expressions, Equations, and Inequalities (Part 2)

You can use $force = mass \times acceleration$ to find the acceleration, force, or mass if you know two of the quantities. For example, if an apple with a mass of $.3 \text{ kg}$ accelerates upward at 10 m/s^2 , you could calculate the amount of force used to lift the apple:

$$f = m \cdot a$$

$$f = .3 \text{ kg} \cdot 10 \text{ m/s}^2$$

$$f = 30 \text{ N}$$

This means that there is a force of 30 newtons (or $30 \text{ kg} \cdot \text{m/s}^2$) acting on the apple to make it accelerate at a rate of 10 m/s^2 . Let's practice using the formula in different situations.

- 7) Cleo is pushing a 160kg sofa with an acceleration of $.25 \text{ m/s}^2$. How much force is she using to push the sofa?
- A. 40 N
 - B. 160.25 N
 - C. 159.75 N
 - D. 740 N
- 8) Andrew is pulling his son in a wagon with a force of 13.5N and an acceleration of $.5 \text{ m/s}^2$. What is the combined weight of Andrew's son and the wagon?
- A. 10 kg
 - B. 13.5 kg
 - C. 27 kg
 - D. 67.5 kg
- 9) If the mass of an object is doubled and force stays the same, what happens to the acceleration?

The Pythagorean Theorem

The Pythagorean equation, $a^2 + b^2 = c^2$, shows the relationship between the lengths of the three sides of a right triangle⁴. A right triangle has one 90° angle. In a right triangle, the side opposite the right angle is called the *hypotenuse*. In the equation above, the length of the hypotenuse is represented by c . The two sides that form a right angle are called *legs* and their lengths are represented by a and b .

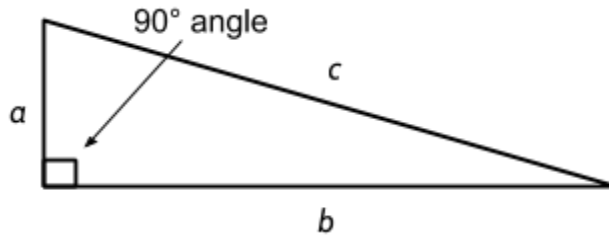

Use $a^2 + b^2 = c^2$ to answer the following questions.

- 10) If $a = 7$ and $b = 24$, what is the length of the hypotenuse, c ?

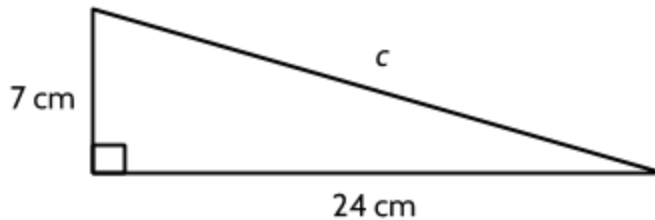

- 11) If $a = 9 \text{ in}$ and $b = 12 \text{ in}$, what is the length of the hypotenuse, c ?

- 12) A right triangle has one leg that is 5 feet long and a hypotenuse that is 13 feet long? How long is the second leg?

$$a = 5 \text{ ft}$$

$$b = \square \text{ ft}$$

$$c = 13 \text{ ft}$$

⁴ Lines, Angles, and Shapes: Measuring Our World includes an introduction to the Pythagorean relationship.

Expressions, Equations, and Inequalities (Part 2)

- 13) Alexandra is drawing a triangle with a leg, a , that has a length of 40 cm and a hypotenuse, c , with a length of 41 cm. Alex calculates that the length of the other leg, b , should be 1 cm but it seems much longer when she draws it. What is her mistake?

- 14) Which of these equations are equivalent to $a^2 + b^2 = c^2$? Choose all that are true.

A. $a^2 = c^2 - b^2$

C. $c = \sqrt{a^2 + b^2}$

B. $b^2 = c^2 - a^2$

D. $a^2 = b^2 - c^2$

- 15) Jermaine and Liz are walking to the grocery store on the other side of Sunset Park. Liz wants to walk on the sidewalk on the outside of the park. Jermaine plans to walk diagonally across the park.

How much farther will Liz walk than Jermaine?

(We recommend using a calculator for this problem.)

- A. 419 feet
B. 1000 feet
C. 1581 feet
D. 2000 feet



Volume of Geometric Figures

In **Lines, Angles, & Shapes: Measuring Our World**, we looked at different topics in geometry, including area and volume. Algebraic formulas have been discovered which can be used to find the measurements of many 2-dimensional and 3-dimensional figures in geometry. For example, there are formulas for the area of rectangles, triangles, and circles. There are also formulas for the volume of rectangular prisms, pyramids, cylinders, cones, and spheres.

Some of these formulas are provided on the high school equivalency exam, but the test writers assume that you know some formulas for area and volume.

<i>These formulas are provided on a reference sheet for the HSE Exam:</i>		<i>These formulas are usually <u>not</u> provided, but the test-writers assume you know them:</i>	
Volume of a cylinder:	$V = \pi r^2 h$	Area of a rectangle:	$A = lw$
Volume of a pyramid:	$V = \frac{1}{3}Bh$	Area of a triangle:	$A = \frac{1}{2}bh$
Volume of a cone:	$V = \frac{1}{3}\pi r^2 h$	Area of a circle:	$A = \pi r^2$
Volume of a sphere:	$V = \frac{4}{3}\pi r^3$	Volume of a rectangular prism:	$V = lwh$
V = volume	r = radius	h = height	B = area of base
			$\pi = 3.1415\dots$

16) Which of these formulas is not on the exam reference sheet?

- A. Volume of a cone
- B. Volume of a cylinder
- C. Volume of a rectangular prism
- D. Volume of a sphere

17) Which of these formulas should you memorize?

Expressions, Equations, and Inequalities (Part 2)

Consider the two rectangular prisms below. (Note: The symbol " means *inches*. For example, 9" means 9 *inches*.)

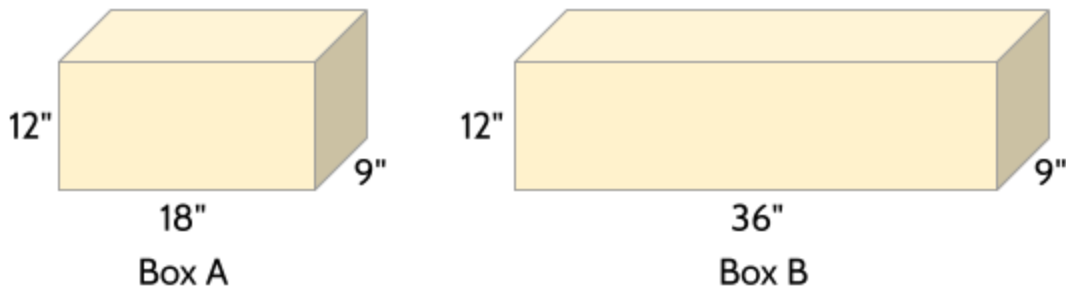

18) Write down everything you know about these two boxes.

Expressions, Equations, and Inequalities (Part 2)

These are the same two boxes, shown with measurements in feet (') instead of inches (").

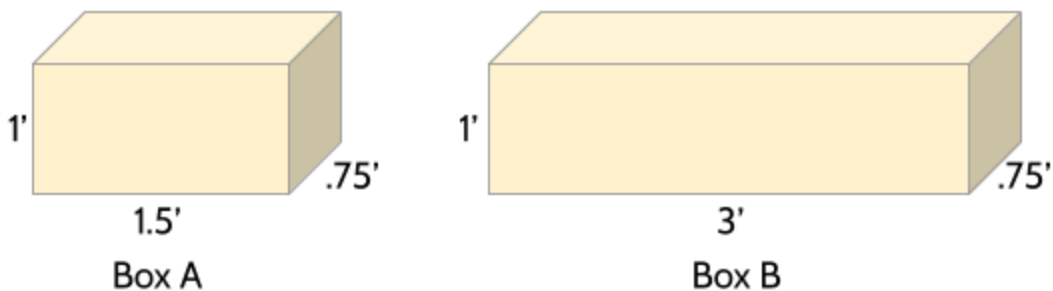

- 19) What is the volume of Box A in cubic feet? Show your work.
- 20) What is the volume of Box B in cubic feet? Show your work.
- 21) If you double the length of a rectangular prism, what happens to the volume?
- A. The volume also doubles.
 - B. The volume stays the same.
 - C. The volume is cut in half.
 - D. The volume is tripled.
- 22) Box C has the following dimensions: $l = 10'$, $w = 12'$, and $h = 5'$. Box D is twice as tall. What is the volume of Box D?

- 23) What happens to the volume of a rectangular prism if you double the length and the width, but don't change the height? Use the two boxes below as examples.

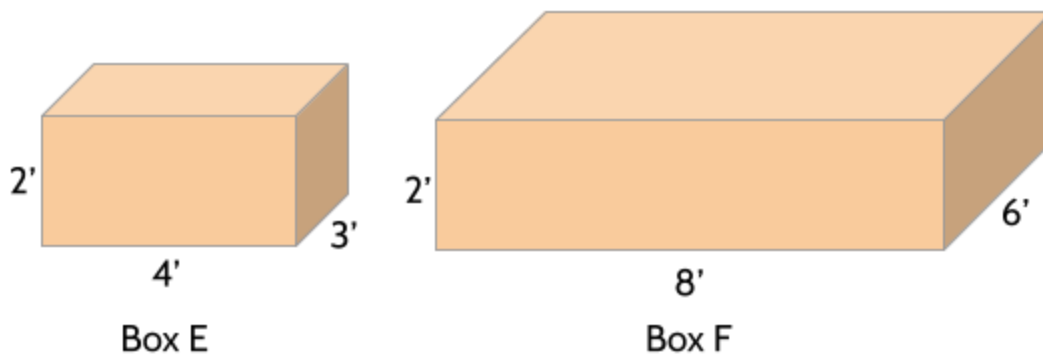

- 24) What happens to the volume of a rectangular prism if you double the length, width, and height? Use box E below as an example.

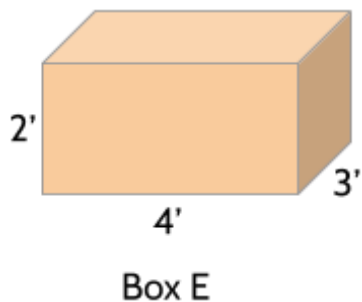

Let's see what happens when we change the measurements of other geometric figures, such as pyramids, cylinders, cones, and spheres. This will also give us practice using the volume formulas for these figures.

We will start with a pyramid.

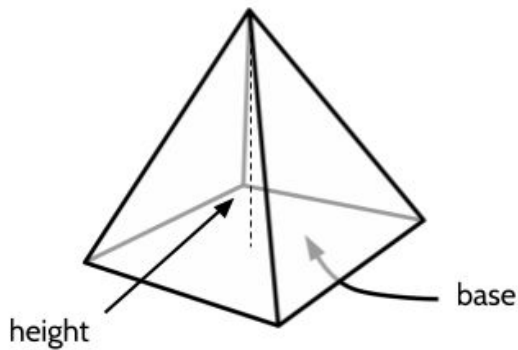

Volume of a pyramid: $V = \frac{1}{3}Bh$

The base (B) refers to the area of the bottom of the pyramid, which in this case is a square. This means that you may have to calculate the area of the square from the length of a side (s).

The height (h) is measured from the top of the pyramid straight down to the middle of the base.

To find the volume of the pyramid, we multiply the area of the base by the height, and then multiply by $\frac{1}{3}$.

- 25) Fill in the blanks in the table. We'll assume the measurements of length are in inches, which means the area is in square inches and the volume is in cubic inches.

Side length (s)	Area of base (B)	Height (h)	Constant	Volume (V)
2 in	4 in^2	3 in	$\frac{1}{3}$	4 in^3
3 in	9 in^2	6 in	$\frac{1}{3}$	
4 in		6 in	$\frac{1}{3}$	
	25 in^2	9 in	$\frac{1}{3}$	
9 in			$\frac{1}{3}$	162 in^3
	49 in^2		$\frac{1}{3}$	196 in^3
2.5 in		4 in	$\frac{1}{3}$	

Expressions, Equations, and Inequalities (Part 2)

26) The Great Pyramid of Giza has a height of 481 feet and the side length of its base is 756 feet. What is the approximate volume of the Great Pyramid?

- A. $5.7 \times 10^5 \text{ ft}^3$
- B. $5.8 \times 10^7 \text{ ft}^3$
- C. $9.2 \times 10^7 \text{ ft}^3$
- D. $2.7 \times 10^8 \text{ ft}^3$

27) Pyramid C has the following dimensions: $B = 144 \text{ ft}^2$ and $h = 10 \text{ ft}$. Pyramid D is 5 feet taller than Pyramid C and has the same size base. How much bigger is the volume of Pyramid D, compared to the volume of Pyramid C? Enter your answer in the grid on the right.

	⊘	⊘	⊘	
•	•	•	•	•
0	0	0	0	0
1	1	1	1	1
2	2	2	2	2
3	3	3	3	3
4	4	4	4	4
5	5	5	5	5
6	6	6	6	6
7	7	7	7	7
8	8	8	8	8
9	9	9	9	9

28) If you double the height of a pyramid, what happens to the volume?

- A. The volume also doubles.
- B. The volume stays the same.
- C. The volume is cut in half.
- D. The volume is tripled.

Now we will look at the volume of a cylinder. A cylinder is a shape with circular ends and long straight sides. A good example of a cylinder is an aluminum can. The volume would be the amount of food or beverage that could be stored inside the can.

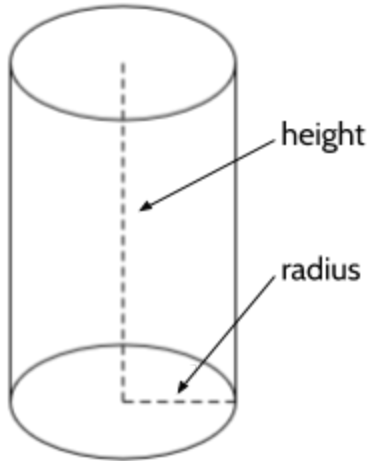

Volume of a cylinder: $V = \pi r^2 h$

The symbol π stands for pi, which represents the number 3.14159... (It's fine to use 3.14 for the calculations you find on the HSE exam.)

The radius (r) refers to the distance from the center of the circle to the edge of the circle.

The height (h) is measured from the top to the bottom of the cylinder.

To find the volume of a cylinder, we square the radius, then multiply by π and the height.

By the way, the calculation of πr^2 by itself is the area of a circle. If you multiply π by the radius squared, you will get the area of the circle at each end of the cylinder. Multiply this area by the height and you have the volume of the cylinder.

29) Fill in the blanks in the table. We'll assume the measurements of length are in inches, which means the area is in square inches and the volume is in cubic inches.

Radius (r)	Radius squared (r^2)	Constant (π)	Height (h)	Volume (V)
2 in	4 in ²	3.14	3 in	37.68 in ³
3 in		3.14	4 in	
5 in		3.14	6 in	
	36 in ²	3.14	5 in	
9 in		3.14		763.02 in ³
	49 in ²	3.14		923.16 in ³

Expressions, Equations, and Inequalities (Part 2)

- 30) A standard soda can is 4.83 inches high and the top has a radius of 1.06 inches. What is the approximate volume of a soda can?
- A. 5 in^3
B. 16 in^3
C. 17 in^3
D. 23 in^3
- 31) Cylinder E has the following dimensions: $h = 30 \text{ cm}$ and $r = 4 \text{ cm}$. Cylinder F has the same radius, but has a height of 5 cm . What is the total volume of the two cylinders? Show your work.

- 32) Identify the constant in the formula $V = \pi r^2 h$.

- A. V
B. π
C. r
D. h

- 33) What is the volume of the cylinder on the right?

- A. 16π
B. 32π
C. 50π
D. 100π

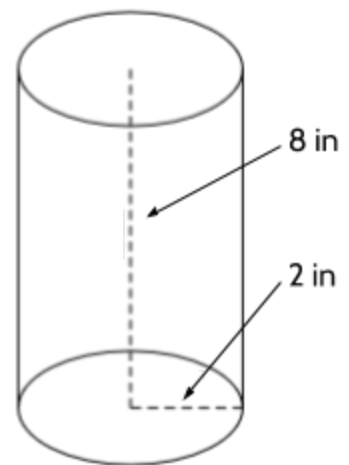

Systems of Equations

The Sum and Difference Problem⁵

- 1) The sum of two numbers is 30 and the difference of the same two numbers is 16.
Can you figure out what the two numbers are?

⁵ Reminder: *Sum* means the answer to an addition problem. 50 is the sum of 40 and 10. *Difference* means how much bigger one number is than the other. There is a difference of 40 between 50 and 10.

Expressions, Equations, and Inequalities (Part 2)

One way to start thinking about the sum and difference problem is to choose two variables and write a couple equations. Since there are two mystery numbers to find, we will need two variables. I'm going to choose a for one number and b for the other number, but you could use any variables, as long as there is one for each number.

Let a be the first number.

Let b be the second number.

The expression $a + b$ is the sum of the two numbers and $a - b$ is the difference between the two numbers.

We know that when we add the two numbers together, we get 30: $a + b = 30$

And we know that when we subtract one number from the other, we get 16: $a - b = 16$

These two equations together are called a *system of equations*.

$$a + b = 30$$

$$a - b = 16$$

There are two equations and each equation has the same two variables. To find a solution to the system of equations, we need to find values for a and b that make both of these equations true.

We could start by trying some pairs of numbers. Could the first number (a) be 20 and the second number (b) be 10? To find out, we can substitute these numbers to see if they make both equations true:

$$20 + 10 = 30 \quad \text{This equation is true.}$$

$$20 - 10 = 16 \quad \text{This equation is false.}$$

Since 20 and 10 only make one of the equations true, these numbers aren't the solution to the system of equations.

- 2) Could the two numbers be 28 and 12? Substitute the numbers in the equations and decide if they are true.

$$\underline{\quad} + \underline{\quad} = 30$$

Expressions, Equations, and Inequalities (Part 2)

$$\underline{\quad} - \underline{\quad} = 16$$

Are 28 and 12 the solutions to the system of equations? Remember that the solutions have to make both equations true. The difference between 28 and 12 is 16, which makes the second equation true, but the sum of these two numbers is 40, which makes the first equation false.

We might want to find a way to organize our guesses, to see if we can find a pattern that will help solve the problem.

Using a Table

One thing we could do is create a table to organize our calculations. We can keep trying pairs of numbers and keep track of the results.

- 3) Fill in the missing blanks in the table with numbers of your own. (Remember that the sum should be 30 and the difference should be 16.)

<i>a</i>	<i>b</i>	sum ($a + b = 30$)	difference ($a - b = 16$)
20	10	30	10
28	12	40	16

- 4) Consider this system of equations.

$$a + b = 30$$

$$a - b = 16$$

What values of a and b are solutions of the system of equations?

- A. $a = 18$ and $b = 12$
- B. $a = 26$ and $b = 10$
- C. $a = 25$ and $b = 3$
- D. $a = 23$ and $b = 7$

When looking for a solution, make sure that the numbers you use for a and b make both equations true.

- 5) The sum of two numbers is 52 and the difference of the same two numbers is 24. Which system of equations could be used to find the two numbers?

- A. $a + b = 24$
 $a - b = 52$
- B. $a + b = 76$
 $a - b = 28$
- C. $a = 24 - b$
 $a = 52 + b$
- D. $a + b = 52$
 $a - b = 24$

The Parking Lot Problem

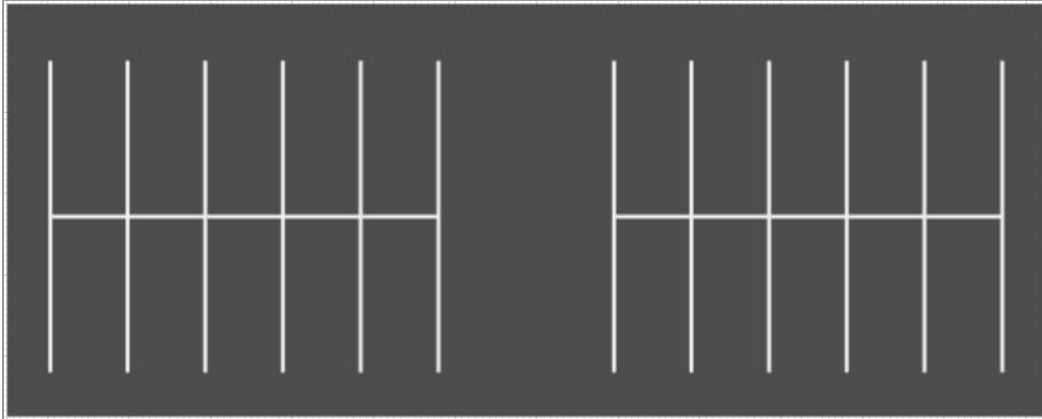

All 20 parking spaces in the parking lot of my favorite restaurant are filled. Some spaces are occupied by cars and others by motorcycles. I counted the total number of wheels in the parking lot and found that there are 66 wheels in total.

- 6) How many cars and how many motorcycles are parked in the lot?

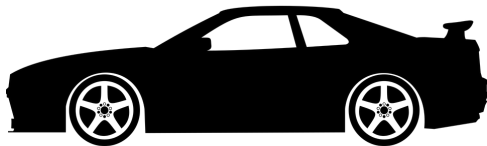

Expressions, Equations, and Inequalities (Part 2)

We can try different numbers of cars and motorcycles and keep track of the results. Could there be 10 cars and 10 motorcycles? This is a total of 20 vehicles which matches the number of parking spaces, but is it the right number of wheels?

Cars have four wheels, so 10 cars have 40 wheels. Motorcycles have two wheels, so 10 motorcycles has 20 wheels. 40 wheels plus 20 wheels is 60 wheels. It's close to the right number of wheels, but we need 66 wheels.

7) Let's use a table to organize our calculations. Fill in the missing blanks in the table with numbers of your own.

number of cars	number of motorcycles	parking spaces used	number of wheels
10	10	20	60
		20	66

Expressions, Equations, and Inequalities (Part 2)

- 8) If the number of cars is x and the number of motorcycles is y , which system of equations could be used to find the number of cars and the number of motorcycles?

A. $x + y = 66$
 $4x + 2y = 20$

C. $x + y = 86$
 $4x + 2y = 120$

B. $x + y = 20$
 $4x + 2y = 66$

D. $x - y = 20$
 $2x + 4y = 66$

- 9) Consider this system of equations.

$$y = 20 - x$$

$$y = 33 - 2x$$

What value of x is a solution to the system of equations?

A. 13

C. 31

B. 20

D. 33

- 10) Liz and Selvija go to the movie theater and purchase refreshments for their friends. Liz spends a total of \$17.50 on two bags of popcorn and three drinks. Selvija spends a total of \$25.00 for four bags of popcorn and two drinks. Let p be the price of popcorn and d be the price of a drink. Which system of equations could be used to find the price of a bag of popcorn and the price of a drink?

A. $p + d = 17.50$
 $2p + 2d = 25.00$

C. $2p + 3d = 17.50$
 $4p + 2d = 25.00$

B. $2p + 3d = 25.00$
 $4p + 2d = 17.50$

D. $17.50p + 25.00d = 5$
 $25.00p + 17.50d = 6$

- 11) Challenge problem: What is the price of a bag of popcorn and the price of a drink?

Inequalities

Number Sentences That Aren't Balanced

In our studies so far, we have spent most of our time looking at number sentences that are balanced between the left side and right side of an equals sign. As you know, these are called *equations*. Equations are true if they are balanced, meaning the value of the left side equals the value of the right side.

However, there are other number sentences besides equations and these different kinds of number sentences don't have to be balanced in order to be true.

The following number sentences are true even though they are not balanced. They are called *inequalities*, because the left side does not have to equal the right side.

$54 \neq 100 - 45$	$21 > 20$	$25 - 12 \geq 10$	$8 \cdot 3 < 7 \cdot 4$	$5 + 10 \leq 20$
54 does not equal 55.	21 is greater than 20.	13 is greater than or equal to 10.	24 is less than 28.	15 is less than or equal to 20.

We can use a number line to show the values that make inequalities true. Here is a number line:

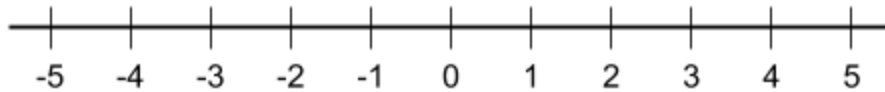

As you move to the right on the number line, the numbers get bigger. As you move to the left, the numbers get smaller. For example, 4 is bigger than 1 and -3 is less than 2. We can show both of these statements as *inequalities*:

$$4 > 1$$



The left side is greater.

$$-3 < 2$$



The right side is greater.

Expressions, Equations, and Inequalities (Part 2)

In an equation, the two expressions on either side of the equals sign must be equivalent for the equation to be true. An inequality is a number sentence where the two expressions do not have to be equivalent.

Here are some examples of inequalities:

Symbol	Example	Written Statement
\neq is not equal to	$63 \neq 21 + 45$	63 is not equal to $21 + 45$.
$>$ is greater than	$12 + 13 > 20$	12 plus 13 is greater than 20.
\geq is greater than or equal to	$x - 10 \geq 5$	x minus 10 is greater than or equal to 5.
$<$ is less than	$44 < 9 \cdot 5$	44 is less than 9 multiplied by 5.
\leq is less than or equal to	$5 + y \leq 20$	5 plus y is less than or equal to 20.

Let's look at a few examples.

- 1) Is $49 \neq 2(5^2)$ a true number sentence?

The number sentence $49 \neq 2(5^2)$ is read as: 49 **is not equal to** 2 multiplied by 5 squared. To find out if this is a true number sentence, we need to evaluate the value of the expression on the right. $2(5^2)$ is the same as 5^2 times 2, which is 50. This is a true statement since 49 is not equal to 50.

- 2) Is $16 \cdot 14 > 15^2$ a true inequality?

The inequality $16 \cdot 14 > 15^2$ is read as: 16 times 14 **is greater than** 15 squared. This is not a true inequality. $16 \cdot 14$ is 224, which is less than 15^2 , which is 225. We could make the inequality true by changing the direction of the *greater than symbol* to turn it into the *less than symbol*: $16 \cdot 14 < 15^2$.

Expressions, Equations, and Inequalities (Part 2)

Are the following number sentences true or false? Explain why.

	Number Sentence	T/F	Explanation
3)	$2(5 + 4) \neq 2 \cdot 5 + 4$	T	This number sentence is true. The value of the left side is 18 and the value of the right is 14. 18 does not equal 14.
4)	$2 \cdot 5^2 \neq \frac{10^2}{2}$		
5)	$(6 + 2)^2 > (5 + 4) \times 5$		
6)	$5^2 - 4^2 < (3 \cdot 2) + 1$		
7)	$\sqrt{49} \cdot 2 < 2^4$		

Write a symbol between two expressions to make a true inequality.

8) $4(6 + 2) > \frac{8^2 - 10}{2}$

9) $25 \quad 11 - 2 \times 4 + 1$

10) $\frac{(4 - 1)^2 \cdot 5}{9} \quad 4(2^2)$

11) $21 \div 7 - 2 + 5^2 \times 3 \quad 75$

12) $2(7 + 3^2) \quad (3 + \frac{32}{8}) \cdot (7 - 2)$

Expressions, Equations, and Inequalities (Part 2)

This number line shows values of v that make the inequality $v > 1$ true.

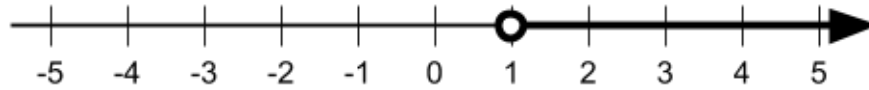

13) Select all the values of v from the list that make $v > 1$ true.

- | | |
|-------|---------|
| A. 3 | D. 700 |
| B. -3 | E. 1.05 |
| C. 1 | F. .99 |

A solution to an inequality is a value that makes the number sentence true, even if it isn't necessarily balanced. An equation has to be balanced to be true. An inequality does not.

14) Name two more values of v that are solutions to the inequality above.

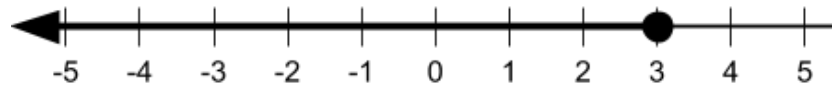

This number line below shows values of w that make the inequality $w \leq 3$ true.



15) Select all the values of w from the list that make $w \leq 3$ true.

- | | |
|-------|---------|
| A. 1 | D. 4.5 |
| B. -2 | E. .5 |
| C. 3 | F. -200 |

16) Name two more values of w that are solutions to the inequality above.

17) Looking back at the two number lines above, what do you think the open circle  and the closed circle  mean? Write down your idea before turning the page.

Expressions, Equations, and Inequalities (Part 2)

On a number line, the open circle  means the number where the open circle is placed **is not** included as a solution. For example, the following number line shows the inequality $x < 2$.

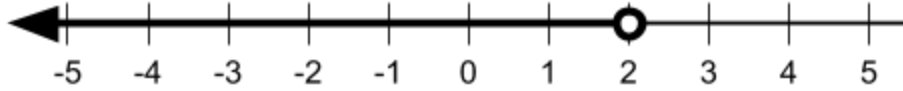

What if x was 2? Would this value make the inequality true?

$2 < 2$ Is this a true number sentence? Is 2 less than 2? No, it isn't true. That's why the number line doesn't include 2. The open circle shows that 2 isn't a solution to this inequality.

The closed circle  means the number where the closed circle is placed **is** included as a solution. For example, the following number line shows the inequality $y \geq -3$.

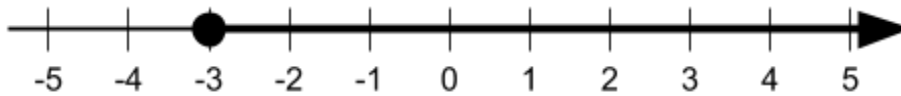

What if y was -3 ? Would this value make the inequality true?

$-3 \geq -3$ Is this a true number sentence? Is -3 greater than or equal to -3 ? Well, -3 isn't greater than -3 , but they are equal, so the number sentence is true. That's why the number line includes -3 . The closed circle shows that -3 is a solution to this inequality.

18) Which inequality does the following number line represent?



- A. $z < 15$
- B. $z \leq 15$
- C. $z > 15$
- D. $z \geq 15$

Expressions, Equations, and Inequalities (Part 2)

19) Which inequality does this number line represent?

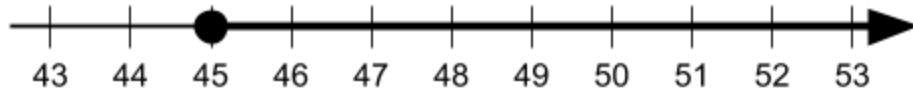

- A. $n < 45$
- B. $n \leq 45$
- C. $n > 45$
- D. $n \geq 45$

20) Graph the solutions to each inequality onto the number lines by drawing arrows and circles.

$$p < 31$$

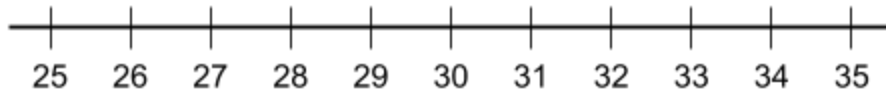

$$q \geq -5$$

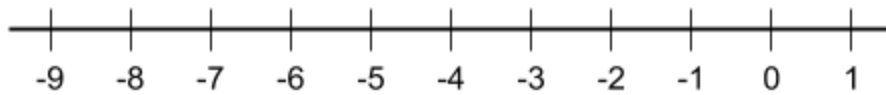

$$r \leq 15 + 6$$

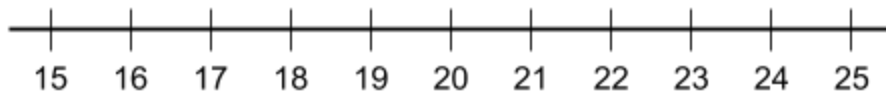

$$15 - 6 < s$$

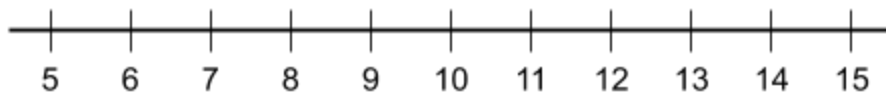

Donations for a Class Party

Consider the following situation:

The high school equivalency class at Ekvilibro Community College decides to hold an end of the year party to celebrate their hard work over the semester. The class wants to provide music and dinner for the students and their families. They will need at least \$400 to rent a hall and cater the event. The class decides to ask for \$5 donations from businesses in the community. If they collect too much money, the class will donate it to the school to buy books.

21) How many donations will the class need to collect in order to fund the party?

22) Fill in the blanks in the table to organize our work on the problem above.

Number of donations	Amount of each donation (\$5.00)	Amount of money collected	Is it enough money?
20	$\times 5$	100	No
40			
60			
80			
100			
120			

Expressions, Equations, and Inequalities (Part 2)

Using the table on the previous page, you should have found that 80 donations of \$5 is enough to fund a \$400 party. Because the number of donations was unknown before we solved the problem, we could have written the following equation to express the situation:

$$\text{Equation: } 5x = 400 \quad \text{Solution: } x = 80$$

However, this equation and solution gives the impression that the class has to have exactly 80 donations, but we know that 81 donations would be fine as well. When people raise money for a cause, they never know how much money they are going to get, but they usually have a goal of a certain amount of money. If they raise more money that they need, that's not a problem.

In this situation, the students want to raise **at least** \$400. They would be happy with more money. If they get more than 80 donations, the extra money would buy books for their classes. We can show this situation with an inequality:

$$\text{Inequality: } 5x > 400 \quad \text{Solution: } x > 80$$

23) Graph the solution onto the number line.

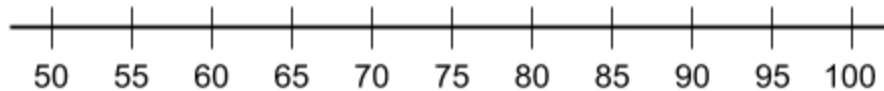

24) Which value of x does not make $5x > 400$ true?

- | | |
|-------|--------|
| A. 80 | C. 100 |
| B. 81 | D. 5 |

In Part 1, we looked at the following problem:

Cleo works at a nursing home and gets paid \$12 per hour. Every week, \$40 is deducted from her wages to help pay for her health insurance. Cleo's weekly expenses are \$500 per week. How many hours will Cleo need to work each week to pay her bills?

Cleo's situation is similar to the party donations above. She has to work at least a certain number of hours to pay her bills, but she could work more. She could save the money or find other ways to spend it.

25) Using h for hours, write an inequality for Cleo's situation.

Graphing Inequalities

So far, we have graphed inequalities on number lines like the one below:

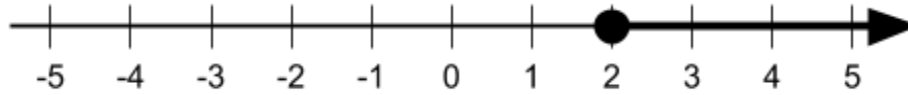

26) The solutions to which inequality is shown above?

- A. $2y > 4$
- B. $2y \geq 4$
- C. $2y \geq 8$
- D. $y < 2$

Some inequalities can be graphed on a coordinate plane⁶. This graph below shows the inequality $x + y \geq 10$.

27) What do you notice when you look at this graph and the inequality $x + y \geq 10$?

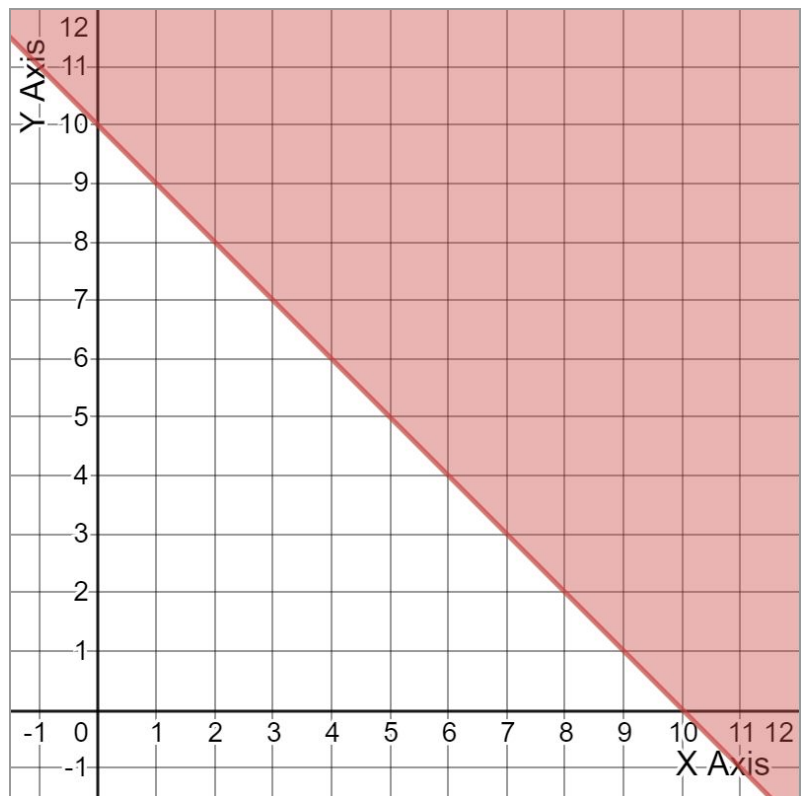

⁶ You can learn more about the coordinate plane in **Rigid Transformations: Shapes on a Plane** and **Tools of Algebra: Linear Functions**.

Expressions, Equations, and Inequalities (Part 2)

This is a graph of the inequality $x + y \geq 10$.

Point A represents a value of 7 on the x axis and a value of 6 on the y axis.

Notice that Point A is in the shaded area of the graph. Point A is a solution to the inequality $x + y \geq 10$ because $7 + 6$ is greater than or equal to 10.

Point A can be written as an *ordered pair* like this: $(7, 6)$. In an ordered pair, the x value is written first and the y value is written second.

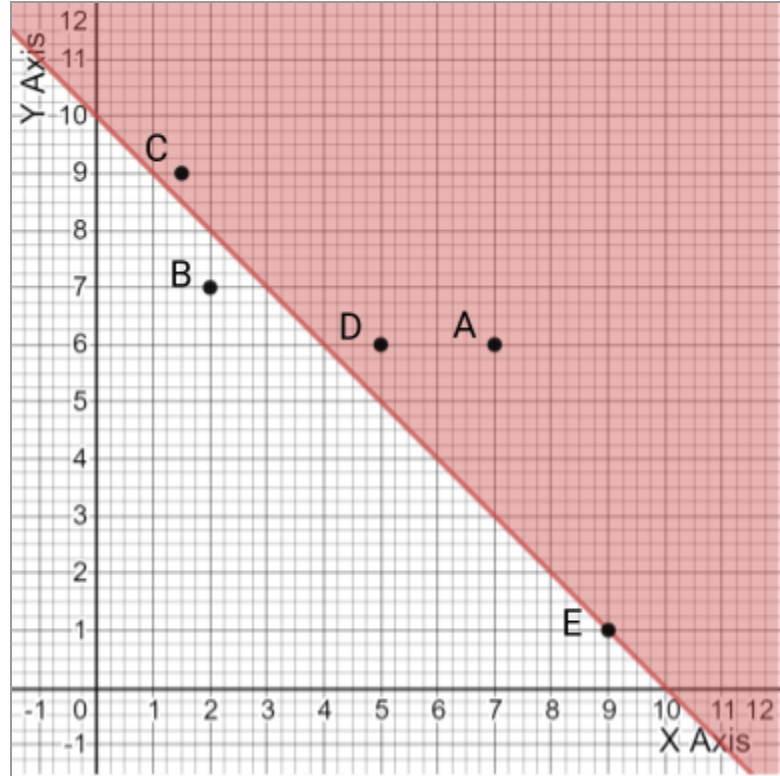

28) Complete the following table.

Point	Ordered Pair	In shaded area, unshaded area, or on the line?	Is it a solution?	Explanation
A	$(7, 6)$	Shaded	Yes	$7 + 6$ is greater than 10
B	$(2, 7)$			
C				
D				
E				

Expressions, Equations, and Inequalities (Part 2)

This is a graph of the inequality $2x - y < 5$.

- 29) Compare this graph of $2x - y < 5$ to the graph of $x + y \geq 10$. What is the same? What is different?

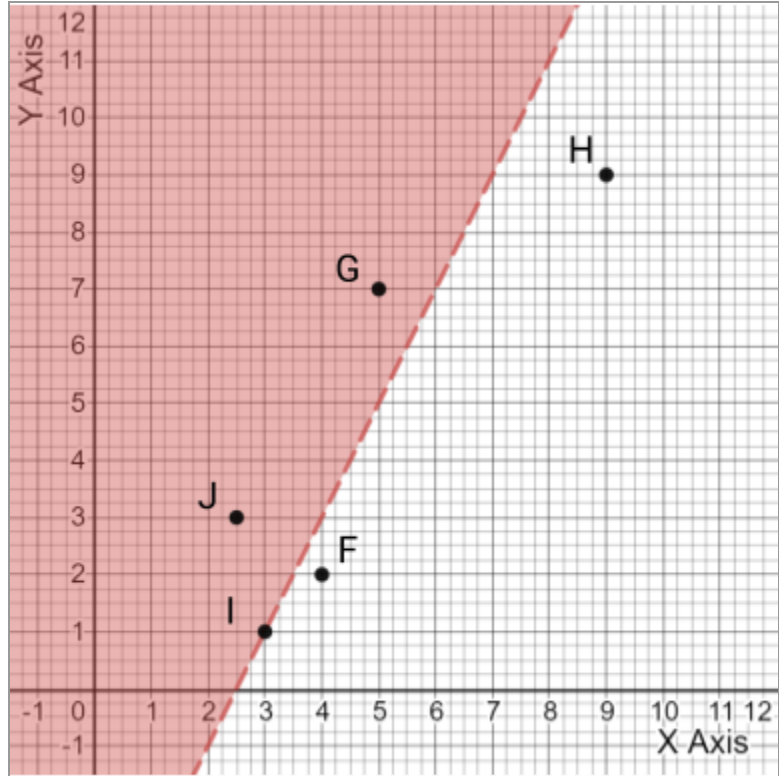

- 30) Complete the following table.

Point	Ordered Pair	In shaded area, unshaded area, or on the line?	Is it a solution?	Explanation
F	(4, 2)	Unshaded		
G				
H				
I				
J				

Expressions, Equations, and Inequalities (Part 2)

- 31) Look back at the last two graphs. Which of these interpretations is correct?
- A. Both points in shaded areas and points in unshaded areas are solutions to the inequality.
 - B. Points in shaded areas are not solutions to the inequality; points in unshaded areas are not solutions to the inequality either.
 - C. Points in shaded areas are solutions and points in unshaded areas are not solutions to the inequality.
 - D. Points in shaded areas are not solutions and points in unshaded areas are solutions to the inequality.

You should have noticed that in each of the two inequality graphs there was one point on the line between the shaded areas and the unshaded areas.

$$x + y \geq 10$$

Point E: (9, 1)

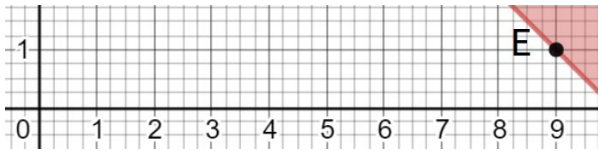

Point E is a solution to the inequality.

$$2x - y < 5$$

Point I: (3, 1)



Point I is not a solution to the inequality.

In the inequality $x + y \geq 10$, Point E is on a solid line:





In the inequality $2x - y < 5$, Point I is on a dashed line:



- 32) What do the solid lines and the dashed lines mean?

Expressions, Equations, and Inequalities (Part 2)

Similar to the open circle  and the closed circle  on a number line, the dashed and solid lines on a graph tells us which numbers are solutions to the inequality and which aren't.

A dashed line - - - on an inequality graph means that points on the line **are not** solutions to the inequality.

In the inequality $2x - y < 5$, try replacing x with 3 and y with 1:

$2(3) - 1 < 5$ Is this a true number sentence? No, it isn't true. 5 is not less than 5.
That's why the line is dashed. Points along the line are **not** solutions to the inequality.

Note: Inequalities with $<$ and $>$ use dashed lines.

33) Which of these points would be on the dashed line in the graph of $2x - y < 5$? Mark all possible answers.

A. (8, 11)

C. (2, 2)

B. (5, 5)

D. (3.5, 2)

A solid line \square on an inequality graph means points on the line **are** solutions to the inequality.

In the inequality $x + y \geq 10$, try replacing x with 9 and y with 1:

$9 + 1 \geq 10$ Is $9 + 1$ greater than or equal to 10. Is this a true number sentence?
Yes, it is true, since $9 + 1$ and 10 are equal. That's why the line is solid.
The solid line shows that all points on the line are true.

Note: Inequalities with \leq and \geq use solid lines. (The graphs of equations also use solid lines.)

34) Which of these points would be on the solid line in the graph of $x + y \geq 10$? Mark all possible answers.

A. (3, 7)

C. (8, 2)

B. (4.5, 5.5)

D. (9.5, 1.5)

Expressions, Equations, and Inequalities (Part 2)

This graph shows solutions to the inequality $x - 3 > y$.

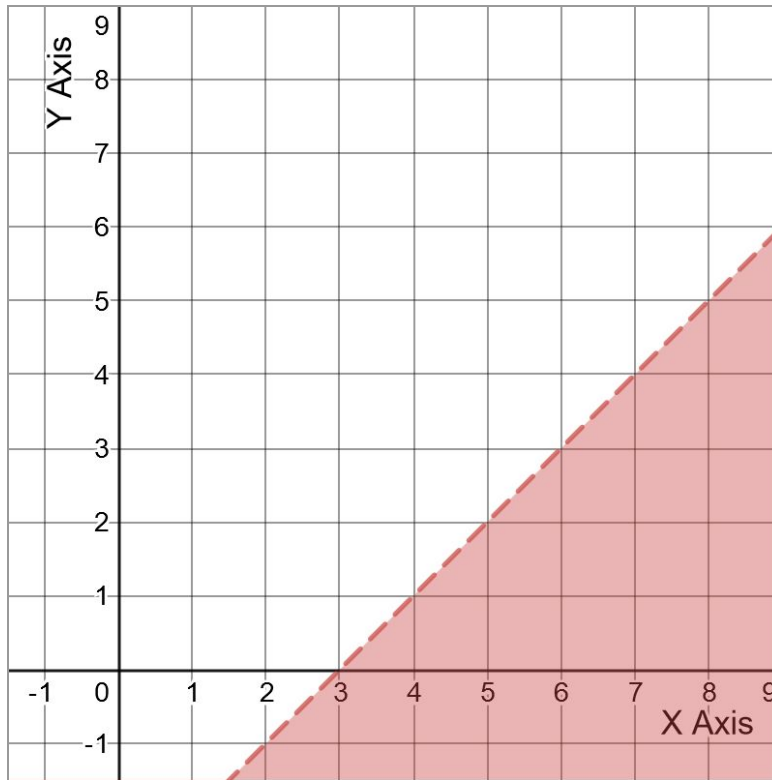

- 35) Write the coordinates of three different points that are in the shaded area of the graph. Example: (8, 2)
- 36) Write the coordinates of three different points that are in the non-shaded area of the graph.

Expressions, Equations, and Inequalities (Part 2)

37) Which inequality is represented by the graph?

- A. $y > 3$
- B. $y < 3$
- C. $y \geq 3$
- D. $y \leq 3$

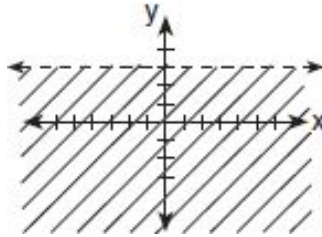

38) Which graph represents the inequality $x \geq 3$?

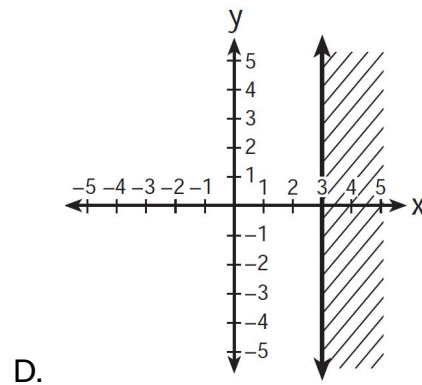
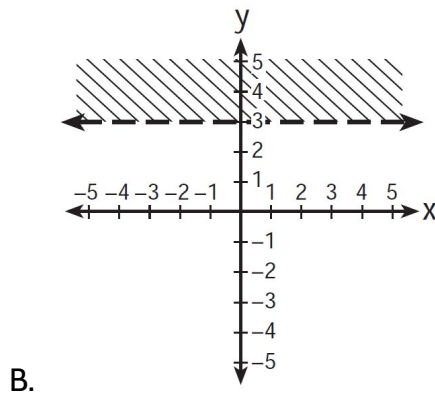
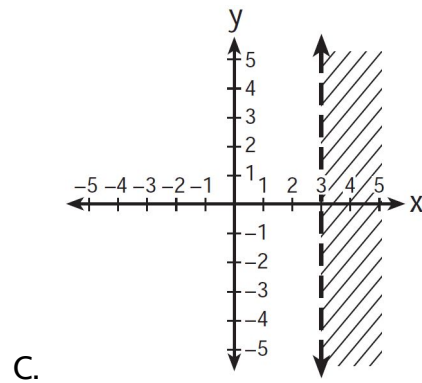
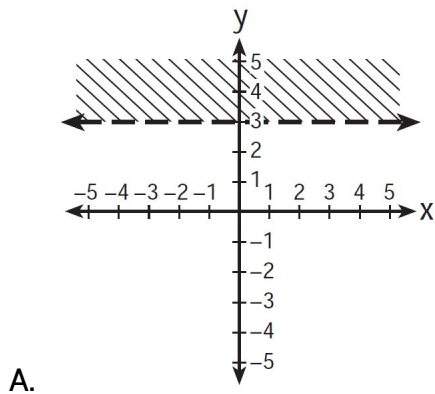

39) Which ordered pair is not in the solution set of $y > 2x + 1$?

- A. (1, 4)
- B. (1, 6)
- C. (3, 8)
- D. (2, 5)

Evaluate Inequalities with Variables

- 40) Which of the following numbers can you put in the box to make the number sentence true?

$$\frac{1}{4} \geq \square$$

- A. $\frac{5}{16}$
- B. $\frac{3}{8}$
- C. $\frac{2}{8}$
- D. $\frac{1}{2}$

- 41) Which of the following fractions make the number sentence true?

$$.625 > \square$$

- A. $\frac{3}{4}$
- B. $\frac{7}{8}$
- C. $\frac{6}{8}$
- D. $\frac{4}{8}$

- 42) Which of the following fractions make the number sentence true?

$$\frac{5}{16} > \square$$

- A. .3
- B. .5
- C. .25
- D. 5

- 43) If \square is 8, is the following inequality true?

$$\frac{\square}{32} < \frac{9}{27}$$

Creating Inequalities

44) Directions: Use the digits 1 to 8, at most one time each, to make a true inequality.

$$\boxed{} \boxed{} > \boxed{} \boxed{} + \boxed{} \boxed{} + \boxed{} \boxed{}$$

Example:

$87 > 16 + 25 + 34$ is true because 87 is greater than 75.

Test Practice Questions

Cylinder:	$V = \pi r^2 h$	$V = \text{volume}$
Pyramid:	$V = \frac{1}{3} B h$	$r = \text{radius}$
Cone:	$V = \frac{1}{3} \pi r^2 h$	$h = \text{height}$
Sphere:	$V = \frac{4}{3} \pi r^3$	$B = \text{area of base}$

Answer the following questions. You can check your answers in [Test Practice Questions - Answer Key](#).

- 1) Which question cannot be answered by the solution to the equation $3x = 27$?
 - A. Elena read three times as many pages as Noah. She read 27 pages. How many pages did Noah read?
 - B. Lin has 27 stickers. She gives 3 stickers to each of her friends. With how many friends did Lin share her stickers?
 - C. Diego paid \$27 to have 3 pizzas delivered and \$35 to have 4 pizzas delivered. What is the price of one pizza?
 - D. The coach splits a team of 27 students into 3 groups to practice skills. How many students are in each group?
- 2) During a sale, an appliance that costs \$275.00 is being sold at a discount for \$220.00. Which equation can be used to find the size of the discount, d , during the sale?
 - A. $220 - d = 275$
 - B. $275 - d = 220$
 - C. $220 - 220d = 275$
 - D. $275 - 275d = 220$

Expressions, Equations, and Inequalities (Part 2)

10) Matthew took the following steps to solve for x in the equation $3(x - 6) = 48$.

Equation: $3(x - 6) = 48$
Step 1: $3x - 18 = 48$
Step 2: $3x = 30$
Step 3: $x = 10$

In which step, if any, did Matthew make an error?

- A. Step 1
- B. Step 2
- C. Step 3
- D. Matthew did not make an error.

11) The equation $0.25x - 50 = 240$ can be used to find the total height of a ramp, in meters, given the distance, x , from the beginning of the ramp.

What is the value of x , in meters? (Write your answer in the grid.)

	/	/	/	
.
0	0	0	0	0
1	1	1	1	1
2	2	2	2	2
3	3	3	3	3
4	4	4	4	4
5	5	5	5	5
6	6	6	6	6
7	7	7	7	7
8	8	8	8	8
9	9	9	9	9

14) Consider the steps Carthian used to evaluate the expression $6 \div 2 \cdot (1 + 2)$.

Expression: $6 \div 2 \cdot (1 + 2)$

Step 1: $6 \div 2 \cdot 3$

Step 2: $6 \div 6$

Step 3: 1

In which step, if any, did Carthian make an error?

- A. Step 1
- B. Step 2
- C. Step 3
- D. Carthian did not make an error.

15) If an object is moving at a constant speed for a certain amount of time, it is possible to find how far the object went by multiplying the rate and the time. In mathematical language, we call this relationship *distance = rate \times time* or $d = r \cdot t$.

Rewrite the equation in terms of rate.

A. $r = d \cdot t$

C. $r = \frac{t}{d}$

B. $r = \frac{d}{t}$

D. $r = t \cdot d$

16) The formula $P = 2l + 2w$ can be used to find the perimeter of a rectangle, P , given the length, l , and the width, w , of the rectangle.

Which interpretation of $2l + 2w$ is correct?

- A. The perimeter of a rectangle is twice the area of the rectangle.
- B. A rectangle has two sides of length l and two sides of length w .
- C. Half of the perimeter of a rectangle is equal to the length of one side of the rectangle.
- D. To find the perimeter of a rectangle, add all the lengths of the sides of the rectangle and double the sum.

- 21) A recreation center ordered a total of 15 tricycles and bicycles from a sporting goods store. The number of wheels for all the tricycles and bicycles totaled 38.

Part A:

How many bicycles did the recreation center order?

- A. 7
B. 8
C. 15
D. 24

Part B:

Which system of equations models this scenario, with t representing the number of tricycles and b representing the number of bicycles ordered?

- A. $3t + 2b = 15$
 $t + b = 38$
B. $3t + 2b = 38$
 $t + b = 15$
C. $3t = 15$
 $2b = 38$
D. $3t - 2b = 15$
 $t - b = 38$

- 22) Alicia purchased some half-gallons of ice cream for \$3.50 each and some packages of ice cream cones for \$2.50 each. She purchased 14 items in total and spent \$43. Which system of equations could be used to determine how many of each item Alicia purchased?

Let H be half-gallons of ice cream.

Let P be packages of ice cream cones.

- A. $3.50H + 2.50P = 14$
 $H + P = 43$
B. $3.50H + 2.50P = 14$
 $H - P = 43$
C. $3.50H + 2.50P = 43$
 $H + P = 14$
D. $3.50H + 2.50P = 43$
 $H - P = 14$

Expressions, Equations, and Inequalities (Part 2)

- 23) Isabella has 30 coins that total \$4.80. All of her coins are dimes, x , and quarters, y .

Part A:

Which system of equations models this situation?

- | | |
|---|---|
| A. $x + y = 4.80$
$.10x + .25y = 30$ | C. $x + y = 30$
$.25x + .10y = 4.80$ |
| B. $x + y = 30$
$.10x + .25y = 4.80$ | D. $x + y = 4.80$
$.25x + .10y = 30$ |

Part B:

Which of the following quantities of coins does Isabella have?

- | | |
|--------------------------|---------------------------|
| A. 28 dimes & 8 quarters | C. 18 dimes & 12 quarters |
| B. 8 dimes & 16 quarters | D. 12 dimes & 18 quarters |
- 24) Consider the following system of equations.

$$2x + 3y = 38$$

$$x + y = 15$$

Which ordered pair is a solution to the system of equations?

- | | |
|-----------|------------|
| A. (7, 8) | C. (12, 3) |
| B. (8, 7) | D. (10, 6) |

Expressions, Equations, and Inequalities (Part 2)

25) The length of a rectangular window is 2 feet more than its width, w . The area of the window is 15 square feet. Which equation could not be used to find the dimensions of the window?

- A. $2w = 15$
- B. $w(w + 2) = 15$
- C. $w^2 + 2w = 15$
- D. $w^2 + 2w - 15 = 0$

26) In the diagram below, Angle FGH has a measure of 90° . Which equation could be used to find the value of x ?

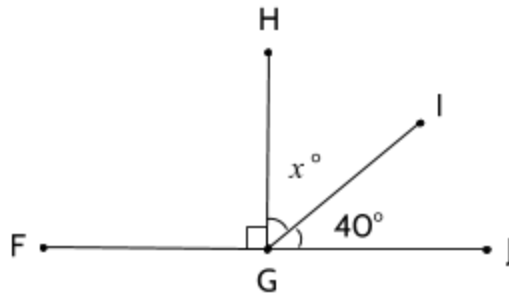

- A. $x - 40 = 180$
- B. $x - 40 = 90$
- C. $x + 40 = 180$
- D. $x + 40 = 90$

Expressions, Equations, and Inequalities (Part 2)

- 27) The formula for the area of a trapezoid is $A = \frac{1}{2}h(b_1 + b_2)$. The area of a trapezoid is 20 square feet, its height is 4 feet, and one base is 7 feet. What is the measurement of the second base of the trapezoid?

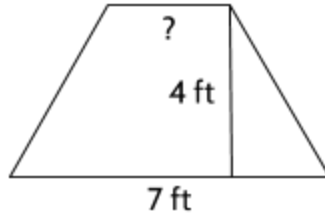

- A. 3 feet
B. 40 feet
C. 54 feet
D. 110 feet
- 28) The formula for finding the area of a square is $A = s^2$. How could you rewrite this formula to solve for s ?
- A. $s = A$
B. $s = A^2$
C. $s = \sqrt{A}$
D. $s = \sqrt{A^2}$
- 29) A moving company sells two cardboard boxes with the same volume. The first box has a length of 25 inches, a width of 12 inches, and a height of 9 inches. The second box has a square base with a side length of 15 inches. What is the height of the second box?
- A. 9 in.
B. 12 in.
C. 15 in.
D. 25 in.

- 30) As shown in the diagram below, a regular pyramid has a square base whose side measures 6 inches. If the height of the pyramid measures 12 inches, its volume, in cubic inches, is

- A. 72
- B. 144
- C. 288
- D. 432

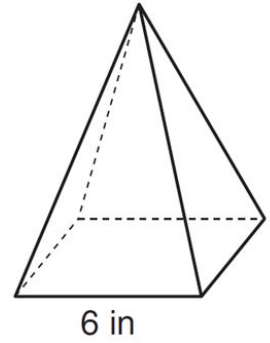

- 31) The pyramid shown below has a square base, a height of 7, and a volume of 84. What is the length of the side of the base?

- A. 6
- B. 12
- C. 18
- D. 36

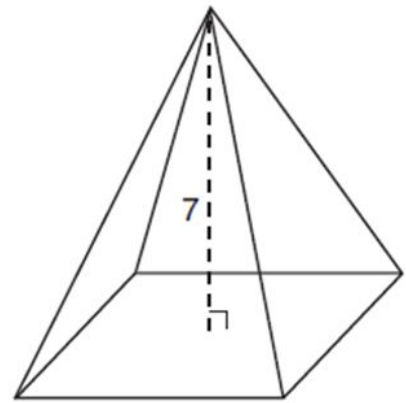

- 32) Which ordered pair satisfies the system of equations below?

$$2x - y = 11$$

$$x + y = 10$$

- A. (5, 5)
- B. (10, 9)
- C. (10, 11)
- D. (7, 3)

33) Amy plans to sell twice as many magazine subscriptions as Shalisa. If Amy and Shalisa need to sell at least 90 subscriptions in all, which inequality could be used to determine how many subscriptions Shalisa, x , needs to sell?

- A. $x \geq 45$
- B. $2x \geq 90$
- C. $2x - x \geq 90$
- D. $2x + x \geq 90$

34) In the diagram below, Line ABE is a straight angle.

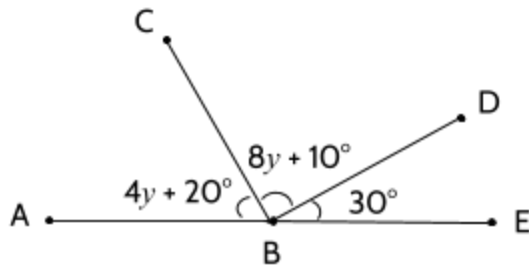

Part A:

Which equation could be used to find the value of y ?

- A. $12y + 60 = 180$
- B. $12y - 60 = 180$
- C. $60 - 12y = 90$
- D. $72y = 180$

Part B:

What is the measure of $\angle CBE$?

- A. 60°
- B. 90°
- C. 120°
- D. 180°

- 35) Ishmael wants to buy strawberries and raspberries to bring to a party. Strawberries cost \$3.50 per pound and raspberries cost \$3.80 per pound.

Part A:

If Ishmael only has \$15 to spend on berries, which inequality represents the situation where he buys x pounds of strawberries and y pounds of raspberries?

- A. $3.5x + 3.8y \leq 15$
- B. $3.5x - 3.8y \leq 15$
- C. $3.5x + 3.8y \geq 15$
- D. $3.5x - 3.8y \geq 15$

Part B:

Which ordered pair is a solution to the inequality?

- A. (2.5, 2)
 - B. (2.5, 1.5)
 - C. (2.5, 2.5)
 - D. (2, 2.5)
- 36) Maxine has a mathematical rule that she uses when it comes to love. Maxine says that, in her opinion, when it comes to the age difference between two people in a romantic relationship, the younger person should never be younger than half the older person's age plus seven more years.

Part A:

Which of the following relationships would not be allowed by Maxine's rule?

- A. a 35 year-old and a 50 year-old
- B. a 24 year-old and a 30 year-old
- C. an 18 year-old and a 21 year-old
- D. a 20 year-old and a 30-year-old

Expressions, Equations, and Inequalities (Part 2)

Part B: Maxine writes her mathematical rule in this way: $y \geq \frac{1}{2}x + 7$.

Which of the graphs below shows this inequality correctly?

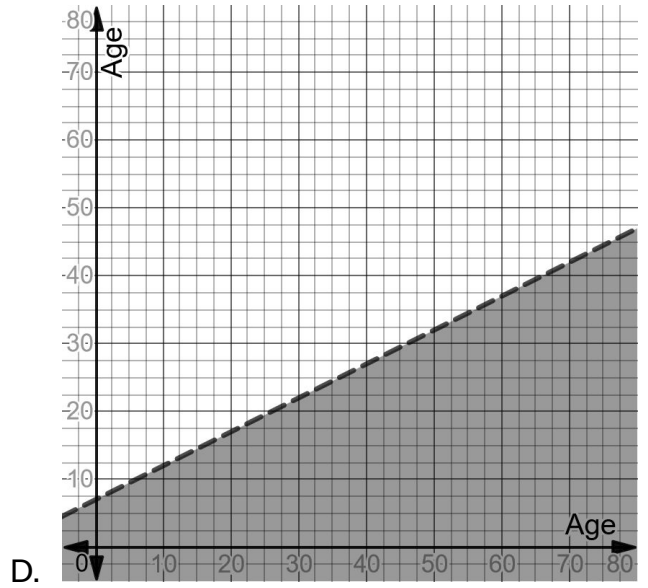
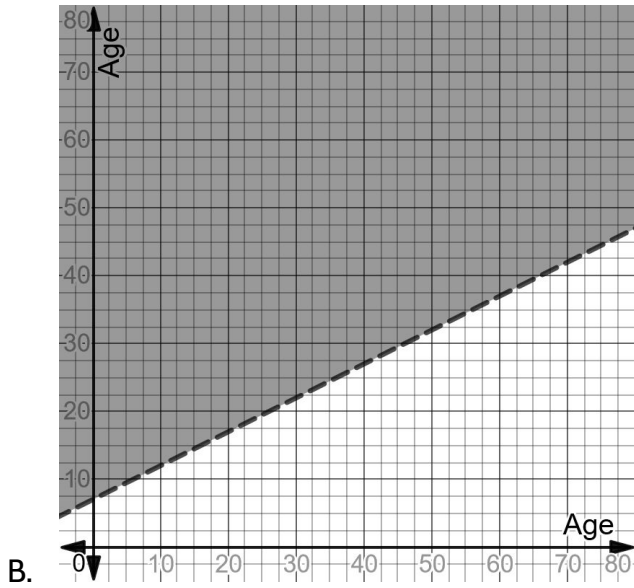
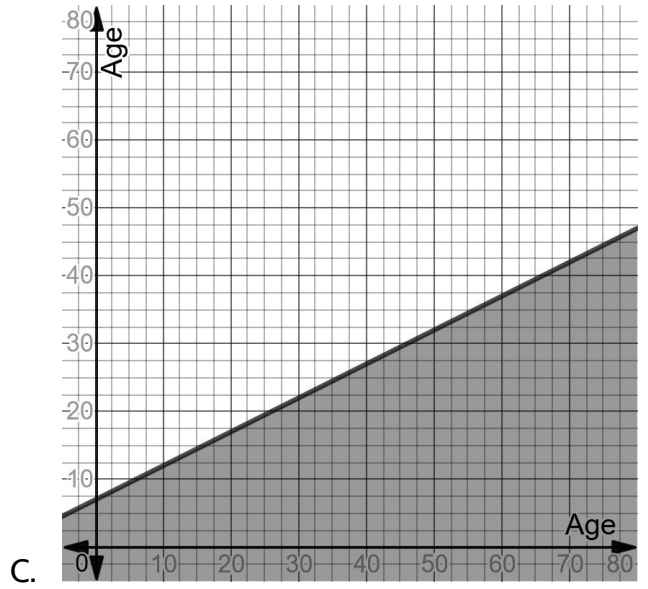
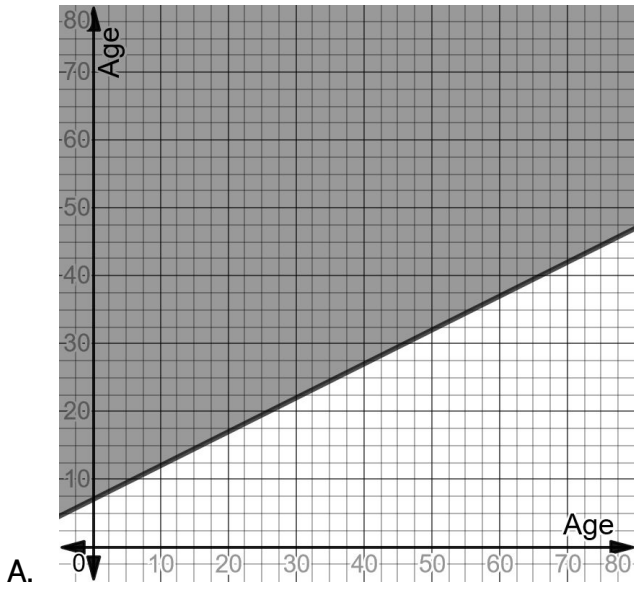

Write a Letter to a Future Student

Take a few minutes to think of a time when you overcame a struggle to learn something. It could be anything—from understanding exponents to learning a technique in baseball to writing an introduction for a difficult essay. Reflect on the times when you failed at first but through persevering your brain created new neural connections and you eventually became better at the task at hand.

- 2) On the back of this paper, write a letter to a future student of your class about this struggle. In at least five sentences, tell this student your story and give them advice on what they should do next time they encounter an obstacle when learning something new. An example is below. Feel free to be as creative as you would like.

Example:

Dear Future Student,

When learning my multiplication tables I found it really hard to memorize the 7's table. With 5 and 10 there's a pattern to their products, but 7 really gets complicated.

I got kind of down for a while, but then I remembered how I learned to make free throws in basketball. It took try after try to get them in. I had to start from two feet from the basket and keep practicing my form. Only after a long time could I make them in with some consistency.

With that in mind, I stuck with it and learned all the way from 7×1 to 7×12 . Even though it took me a little longer than other students at that time, I am now able to recall them very easily. Stick with what you're working on. The struggle means you're getting close.

Sincerely,

Charlie

Answer Keys

Variables

1) Answers:

$$u = 6$$

$$v = 38$$

$$w = 8$$

$$x = 3$$

$$y = 3.25$$

$$z = 4 \text{ or } -4$$

2)

A (area)	L (length)	W (width)
30 square inches	5 inches	6 inches
24 square feet	8 feet	3 feet
36 square inches	4 inches	9 inches
100 square yards	25 yards	yards
10 square inches	$\frac{1}{2}$ inches	20 inches
500 square miles	25 miles	20 miles

3) The important idea is that the order in which two quantities are multiplied doesn't matter. You will get the same answer either way.

4) This is one way to show the associative property with these values:

$$(4 + 12) + 7 = 4 + (12 + 7)$$

$$16 + 7 = 4 + 19$$

$$23 = 23$$

5) You should have gotten \$40 as the total. Did you find any tricks to make it easier to add the numbers?

6) You should get the same answer each time.

7) Yes.

Expressions, Equations, and Inequalities (Part 2)

8)

associative property of multiplication: $(a \cdot b) \cdot c = a \cdot (b \cdot c)$			
Values for a , b , & c	Left Expression	Right Expression	T/F
$a = 5$ $b = 6$ $c = 3$	$(5 \cdot 6) \cdot 3$ $30 \cdot 3$ 90	$5 \cdot (6 \cdot 3)$ $5 \cdot 18$ 90	T
$a = 10$ $b = 5$ $c = 4$	$(10 \cdot 5) \cdot 4$ $50 \cdot 4$ 200	$10 \cdot (5 \cdot 4)$ $10 \cdot 20$ 200	T
$a = 6$ $b = 8$ $c = \frac{1}{2}$	$(6 \cdot 8) \cdot \frac{1}{2}$ $48 \cdot \frac{1}{2}$ 90	$6 \cdot (8 \cdot \frac{1}{2})$ $6 \cdot 4$ 24	T

9) Subtraction does not have an associative property.

$$(20 - 12) - 6 \neq 20 - (12 - 6)$$

$$8 - 6 \neq 20 - 6$$

$$4 \neq 14$$

10)

Equation	Explanation
$a + b = b + a$	It doesn't matter what order you add two numbers. Example: $5 + 12 = 12 + 5$.
$a \cdot b = b \cdot a$	It doesn't matter what order you add two numbers. Example: $5 \times 12 = 12 \times 5$.
$(a + b) + c = a + (b + c)$	It doesn't matter how numbers are grouped in addition. Example: $(6 + 2) + 3 = 6 + (2 + 3)$
$(a \cdot b) \cdot c = a \cdot (b \cdot c)$	It doesn't matter how numbers are grouped in multiplication. Example: $(6 \times 2) \times 3 = 6 \times (2 \times 3)$
$a \cdot (b + c) = a \cdot b + a \cdot c$	A number multiplied by the sum of two numbers is equal to the sum of the first number multiplied by each of the other numbers. Example: $4(5 + 2) = 4 \times 5 + 4 \times 2$

11) $x > 25$

12) $20 < z < 30$

Expressions and Equations II

- 1) Here is an example using 555-1212, which is the number for directory assistance with the phone company:

$$555 \cdot 40 = 22,200$$

$$22,200 + 1 = 22,201$$

$$22,201 \cdot 500 = 11,100,500$$

$$11,100,500 + 1212 = 11,101,712$$

$$11,101,712 + 1212 = 11,102,924$$

$$11,102,924 - 500 = 11,102,424$$

$$11,102,424 \div 2 = 5,551,212 \rightarrow 5551212$$

- 2) One solution could be $a = 2$, $b = 3$, and $c = 20$. There are many different values that will work for a , b , and c .
- 3) One solution could be $x = 4$, $y = 6$, and $z = 22$. There are many different values that will work for x , y , and z .
- 4) The variable v represents the number of flyers the three final volunteers received after 5 flyers went to the first volunteer and 18 went to the second volunteer. Each of three final volunteers received v flyers.
- 5) Each of the five volunteers got some number of stickers (we don't know how many) plus 2 more each at the end. The total number of stickers given out was 30 stickers.
- 6) Here is one way of drawing the tape diagram. You can use any variable you like for these.

Expressions, Equations, and Inequalities (Part 2)

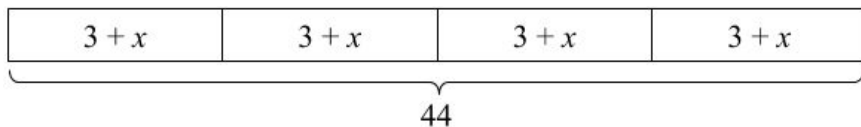

7)

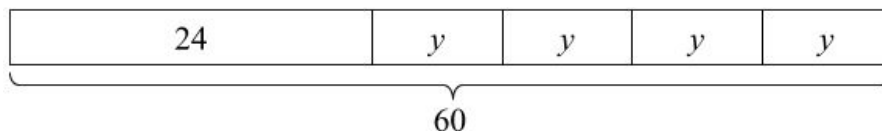

8)

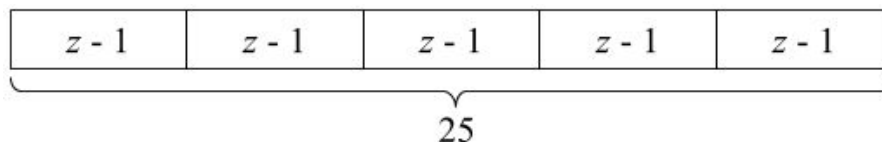

- 9) C. The expression $x - 1$ represents a bag with 1 apple removed. There are four bags of apples. The variable x represents the number of apples in a bag before any have been removed. Here is one way to find the unknown amount:

$$\begin{aligned} 4 \cdot (z - 1) &= 28 \\ 4z - 4 &= 28 \\ 4z - 4 + 4 &= 28 + 4 \\ 4z &= 32 \\ z &= 8 \end{aligned}$$

10) A, B, D, F

11) B, E

12) Be creative. There are many different stories that could match this diagram.

13) There are many situations that could be represented by these two diagrams, but in each one the top diagram is equal to the bottom diagram. This means that the following equation could represent the situation as well: $3w + 8 = 5w + 2$

14) $w = 3$

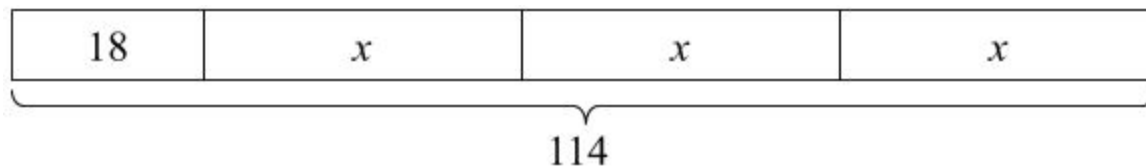

15)

Expressions, Equations, and Inequalities (Part 2)

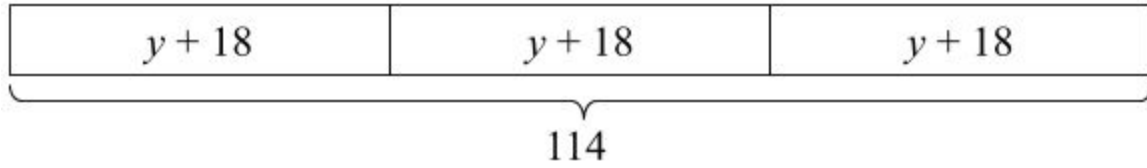

16) $x = 32, y = 20$

17) $v = 4, w = 4, x = 4, y = 4$

18) The value of the expression is 25.

Original expression: $3x + 5 + 2x^2 - 3 + 8x + x^2 - 11x + 5x - 3x^2 + 4 - 3x - 6 - 2x + x^2$

Expression with 5 substituted for x :

$$3(5) + 5 + 2(5)^2 - 3 + 8(5) + (5)^2 - 11(5) + 5(5) - 3(5)^2 + 4 - 3(5) - 6 - 2(5) + (5)^2$$

Value of each term: $15 + 5 + 50 - 3 + 40 + 25 - 55 + 25 - 75 + 4 - 15 - 6 - 10 + 25$

Overall value: 25

19)

written as multiplication	written as repeated addition	value
3×5	$5 + 5 + 5$	15
$4 * 9$	$9 + 9 + 9 + 9$	36
$(3)(8)$	$8 + 8 + 8$	24
$7 \cdot v$	$v + v + v + v + v + v + v$	$7v$

20) Yes. Look for an explanation after the question.

21) Yes. Look for an explanation after the question.

22) $13x$

23) $10v + 10w$. Be careful: These are two different variables, so we can't add them together.

24)

x	Substitute for x	Value of expression	Substitute for x	Value of expression	Equivalent?
1	$12(1)$	12	$10(1) + 2$	12	Yes
2	$12(2)$	24	$10(2) + 2$	22	No
3	$12(3)$	36	$10(3) + 2$	32	No

Expressions, Equations, and Inequalities (Part 2)

4	$12(4)$	48	$10(4)+2$	42	No
---	---------	----	-----------	----	----

- 25) No. The first expression simplifies to $8w + 12$. The second expression simplifies to $8 + 12w$.
- 26) True. Twenty-five x 's minus nine x 's is sixteen x 's.
- 27) False. $5x$ is not equal to 5 . Subtracting x doesn't make the x disappear, since the expression is saying, "Take one x away from six x 's."
- 28) True. Both sides are equal to $5x + 4$.
- 29) False. $10 - 2x$ is not the same as $8x$. The number is 10, not ten x 's.
- 30) $7 - 4(x + 2)$ is not equivalent to $3(x + 2)$. The expression tells us to subtract four copies of an amount from 7, not to take $(7 - 4)$ copies of the amount.
- 31) Look back to the text for an explanation.
- 32) $8w + 5$
- 33) $12x - 3y$
- 34) $7.5z^2 - 2.5$
- 35) $5v + 2.5v^2 - 2$ (It is already in simplified form.)
- 36) If you simplify the expression before substituting 5 for x , you should end up with x^2 by itself. All of the other terms will disappear so that you don't have to do any other calculations. This is why simplifying is a useful skill to know. It can make solving equations easier. The value is $5^2 = 25$.

Solving Equations

- 1) $x = 7$
- 2) Look back to the text for an explanation.
- 3) $x = 10$

Expressions, Equations, and Inequalities (Part 2)

4) B

5) Your work might look like this:

$$5(x + 4) = 70$$

$$5x + 20 = 70$$

$$5x + 20 - 20 = 70 - 20$$

$$5x = 50$$

$$x = 10$$

6) $v = 12$

7) $w = 15$

8) $x = 20$

9) $y = 30$

10) $2n + 1 = 11$

$$2n = 10$$

$$n = 5$$

11) $5n + 6 = 26$

$$5n = 20$$

$$n = 4$$

12) $\frac{n}{2} - 4 = 11$

$$\frac{n}{2} = 16$$

$$n = 32$$

13) $(n + 3) \cdot 2 = 20$

$$n + 3 = 10$$

$$n = 7$$

14) $\frac{n-2}{4} = 3$

$$n - 2 = 12$$

$$n = 14$$

15) $\frac{3n+2}{4} = 5$

$$3n + 2 = 20$$

$$3n = 18$$

Expressions, Equations, and Inequalities (Part 2)

$$n = 6$$

$$\begin{aligned} 16) \quad \frac{3(n+2)}{5} &= 9 \\ 3(n+2) &= 45 \\ n+2 &= 15 \\ n &= 13 \end{aligned}$$

$$\begin{aligned} 17) \quad \left(\frac{n}{3} + 4\right) \cdot 2 &= 20 \\ \frac{n}{3} + 4 &= 10 \\ \frac{n}{3} &= 6 \\ n &= 18 \end{aligned}$$

$$\begin{aligned} 18) \quad \frac{3n+2}{2} - 1 &= 3 \\ \frac{3n+2}{2} &= 4 \\ 3n+2 &= 8 \\ 3n &= 6 \\ n &= 2 \end{aligned}$$

$$\begin{aligned} 19) \quad \frac{4^2+11}{3} &= n \\ \frac{16+11}{3} &= n \\ \frac{27}{3} &= n \\ 9 &= n \end{aligned}$$

$$\begin{aligned} 20) \quad \frac{\sqrt{7+9}-2}{2} &= n \\ \frac{\sqrt{16}-2}{2} &= n \\ \frac{4-2}{2} &= n \\ \frac{2}{2} &= n \\ 1 &= n \end{aligned}$$

$$\begin{aligned} 21) \quad 4\left(\frac{2n}{5} + 7\right) &= 44 \\ \frac{8n}{5} + 28 &= 44 \\ \frac{8n}{5} &= 16 \\ 8n &= 80 \\ n &= 10 \end{aligned}$$

$$22) \quad v = 3$$

Expressions, Equations, and Inequalities (Part 2)

23) A

24) B

25) B

26) There are two possible equations with the largest possible value for x :

Both $1x - 9 = 8$ or $1x - 8 = 9$ have a value for x of 17.

27) $area \div length = width$

$$area = width \cdot length$$

28) $\frac{d}{t} = r$

$$d = r \cdot t$$

29) $\frac{mass}{density} = volume$

$$mass = volume \cdot density$$

30) $density \cdot area = population$

$$density = \frac{population}{area}$$

31) $\frac{C}{2\pi} = r$

$$C = r \cdot 2\pi$$

32) $\frac{3V}{h} = B$

$$3V = Bh$$

$$V = \frac{1}{3}Bh$$

33) $\frac{F-32}{9} \cdot 5 = C$

$$\frac{F-32}{9} = \frac{C}{5}$$

$$F - 32 = \frac{C}{5} \cdot 9$$

$$F = \frac{C}{5} \cdot 9 + 32$$

34) $\frac{b^2}{5+4} + 4 = 5$

$$\frac{b^2}{5+4} = 9$$

$$\frac{b^2}{9} = 9$$

$$b^2 = 81$$

$$b = 9 \text{ or } -9$$

Using Formulas

1)

Mode of Travel	Distance d (miles)	Time t (hours)	Rate r (miles per hour)
Car	130	2	65
Car	150	5	30
Bike	22.5	2.5	9
Walking	7.5	2.5	3
Boat	8	.5	2
Plane	1750	3.5	500

2) A) True. $8 \div .5$ is 16.

B) True. $16 \times .5$ is 8.

C) False. 16 does not equal $.5 \times 8$.

D) True. $.5$ does equal $\frac{8}{16}$.

3) D, B, A

4) A

5) The distance is cut in half.

6) Neptune is about 2.684×10^9 or 2,684,000,000 miles from the Sun. This is 4 times the distance light travels in 1 hour.

7) A

8) C

Expressions, Equations, and Inequalities (Part 2)

- 9) The acceleration is cut in half. Since the object is heavier and the same amount of force is the same, it doesn't move as much.
- 10) 25 cm
- 11) 15 in
- 12) 12 ft
- 13) It seems that Alexandra forgot to square 40cm and 41cm. If you solve for b in the equation $41^2 = 40^2 + b$, you will find that $b = 9$ cm.
- 14) A, B, C
- 15) A
- 16) C
- 17) This is your decision, but we recommend that you understand how to find the area of a rectangle, the area of a triangle, the area of a circle, and the volume of a rectangular prism without needing to look up the formula. You won't have access to these formulas at the test.
- 18) There are many things you might write here. Here are a few things we see:
- Box A and Box B have the same height and depth.
 - Both boxes are 12 inches or 1 foot tall.
 - Box B is twice as wide as Box A.
 - The volume of Box A is 1944 in^2 and the volume of Box B is 3888 in^2 .
- 19) $1 \text{ ft} \cdot 1.5 \text{ ft} \cdot .75 \text{ ft} = 1.125 \text{ ft}^2 = 1\frac{1}{8} \text{ ft}^2$
- 20) $1 \text{ ft} \cdot 3 \text{ ft} \cdot .75 \text{ ft} = 2.25 \text{ ft}^2 = 2\frac{1}{4} \text{ ft}^2$
- 21) A
- 22) $10 \text{ ft} \cdot 12 \text{ ft} \cdot 10 \text{ ft} = 1200 \text{ ft}^2$

Expressions, Equations, and Inequalities (Part 2)

23) The volume of Box E: $2\text{ ft} \cdot 4\text{ ft} \cdot 3\text{ ft} = 24\text{ ft}^3$

The volume of Box F: $2\text{ ft} \cdot 8\text{ ft} \cdot 6\text{ ft} = 96\text{ ft}^3$

Box F has 4 times the volume of Box E.

24) The volume of Box E: $2\text{ ft} \cdot 4\text{ ft} \cdot 3\text{ ft} = 24\text{ ft}^3$

If you double the length, width, and height: $4\text{ ft} \cdot 8\text{ ft} \cdot 6\text{ ft} = 192\text{ ft}^3$

The new box would have 8 times the volume of Box E.

25)

Side length (s)	Area of base (B)	Height (h)	Constant	Volume (V)
2 in	4 in^2	3 in	$\frac{1}{3}$	4 in^3
2 in	9 in^2	6 in	$\frac{1}{3}$	18 in^3
4 in	16 in^2	6 in	$\frac{1}{3}$	32 in^3
5 in	25 in^2	9 in	$\frac{1}{3}$	75 in^3
9 in	81 in^2	6 in	$\frac{1}{3}$	162 in^3
7 in	49 in^2	12 in	$\frac{1}{3}$	196 in^3
2.5 in	6.25 in^2	6 in	$\frac{1}{3}$	12.5 in^3

26) C

27) 240

28) A

29)

Radius (r)	Radius squared (r^2)	Constant (π)	Height (h)	Volume (V)
2 in	4 in^2	3.14	3 in	37.68 in^3
3 in	9 in^2	3.14	4 in	113.04 in^3
5 in	25 in^2	3.14	6 in	471 in^3
6 in	36 in^2	3.14	5 in	565.2 in^3
9 in	81 in^2	3.14	3 in	763.02 in^3
7 in	49 in^2	3.14	6 in	923.16 in^3

30) C

31) 1758.4 cm^2

32) B

- 33) B. The calculated volume would be about 100 in^3 , but the answer here is left in units of π . You may see answer choices like this on the actual exam. This means that they left π as it is and didn't calculate 3.14 into the answer: $\pi \cdot 2^2 \cdot 8 = \pi \cdot 32 = 32\pi = 100.48 \text{ in}^2$

Systems of Equations

- 1) This problem is explained in the text.
- 2) $28 + 12 = 30$ This is not a true equation.
 $28 - 12 = 16$ This is a true equation.
- 3) Try at least 5 different pairs of numbers to see if you can figure out what the two numbers are.
- 4) D. (23 and 7 are two numbers that added together are equal to 30 and whose difference is 16.)
- 5) D
- 6) This problem is explained in the text.
- 7) Try at least 5 different pairs of numbers to see if you can figure out what the number of cars and motorcycles are.
- 8) B
- 9) A
- 10) C
- 11) A bag of popcorn is \$5.00 and a drink is \$2.50.

Inequalities

- 1) Yes, it's true that 49 does not equal 50.
- 2) No, 224 is less than 225. This number sentence would need to be rewritten as $16 \cdot 14 < 15^2$ to be true.
- 3) True. This number sentence is true. The value of the left side is 18 and the value of the right is 14. 18 does not equal 14.

Expressions, Equations, and Inequalities (Part 2)

- 4) False. 100 does equal 100.
- 5) True. 64 is greater than 45.
- 6) False. 9 is not less than 7.
- 7) True. 14 is less than 16.
- 8) $32 > 27$
- 9) $25 > 4$
- 10) $5 < 16$
- 11) $76 > 75$
- 12) $32 < 35$
- 13) A, D, E
- 14) Any number greater than 1 would be a solution for the inequality.
- 15) A, B, C, E, F
- 16) Any number less than or equal to 3 would be a solution for the inequality.
- 17) This is explained in the text.
- 18) C
- 19) D

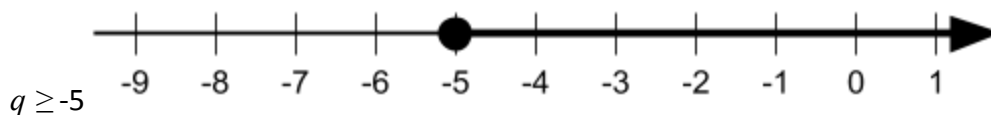
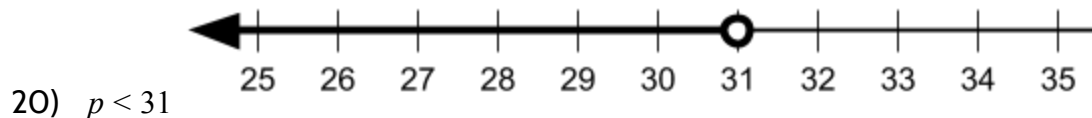

Expressions, Equations, and Inequalities (Part 2)

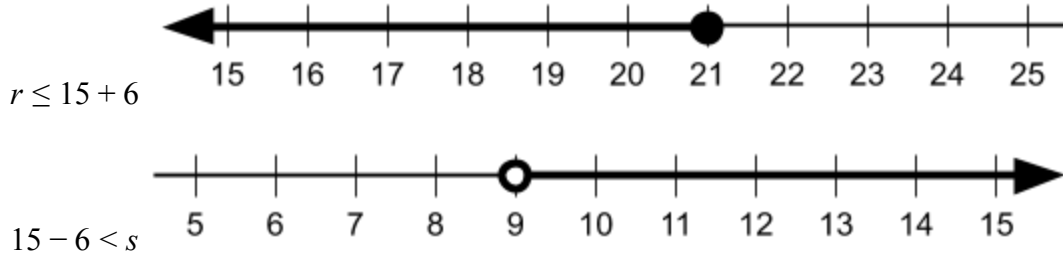

You may have been expecting this last number line to have an arrow pointing to the left since the symbol is “less than.” However, the variable s is now on the other side of the inequality, which changes the relationship. 9 is less than s , which means that s is greater than 9. This inequality could be rewritten as $s > 15 - 6$. Compare this inequality with the number line above.

21) The class will need to collect at least 80 donations.

22)

Number of donations	Amount of each donation (\$5.00)	Amount of money collected	Is it enough money?
20	$\times 5$	100	No
40	$\times 5$	200	No
60	$\times 5$	300	No
80	$\times 5$	400	Yes
100	$\times 5$	500	Yes
120	$\times 5$	600	Yes

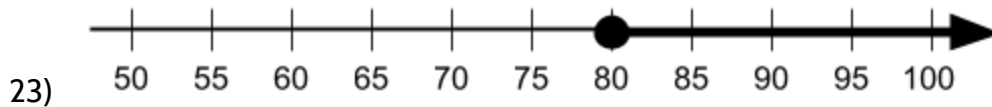

23)

24) D

25) $12h - 40 \geq 500$

26) B

27) There are many things to notice. We point out some of them in the text.

Expressions, Equations, and Inequalities (Part 2)

28) $x + y \geq 10$

Point	Ordered Pair	In shaded area, unshaded area, or on the line?	Is it a solution?	Explanation
A	(7, 6)	Shaded	Yes	$7 + 6$ is greater than 10
B	(2, 7)	Unshaded	No	$2 + 7$ is less than 10
C	(1.5, 9)	Shaded	Yes	$1.5 + 9$ is greater than 10
D	(5, 6)	Shaded	Yes	$5 + 6$ is greater than 10
E	(9, 1)	On the line	Yes	$9 + 1$ is equal to 10

29) There are many things to notice. We point out some of them in the text.

30) $2x - y < 5$

Point	Ordered Pair	In shaded area, unshaded area, or on the line?	Is it a solution?	Explanation
F	(4, 2)	Unshaded	No	$2(4) - 2$ equals 6, which is greater than 5
G	(5, 7)	Shaded	Yes	$2(5) - 7$ equals 3, which is less than 5
H	(9, 9)	Unshaded	No	$2(9) - 9$ equals 9, which is greater than 5
I	(3, 1)	On the line	No	$2(3) - 1$ equals 5
J	(2.5, 3)	Shaded	Yes	$2(2.5) - 3$ equals 2, which is less than 5

31) C

32) The dashed line means that points on the line are not solutions to the inequality. The solid line means points on the line are solutions to the inequality.

33) A, B, D

34) A, B, C

35) There are many different points in the shaded area. $(8, 2)$ is in the shaded area because $8 - 3 > 2$ is true.

36) There are many different points in the unshaded area. $(5, 3)$ is an example of point in the unshaded area. It is in the unshaded area because $5 - 3 > 3$ is not true.

37) A

Expressions, Equations, and Inequalities (Part 2)

38) D

39) D

40) C

41) D

42) C

43) Yes. $\frac{8}{32}$ is equal to $\frac{1}{4}$. $\frac{9}{27}$ is equal to $\frac{1}{3}$. $\frac{1}{4}$ is smaller than $\frac{1}{3}$.

44) There are many different solutions to this problem. Here are a few:

8, 4, 3, 5, 2, 6, 1, 7

8, 5, 3, 7, 2, 4, 1, 6

8, 6, 4, 7, 2, 3, 1, 5

8, 5, 3, 4, 2, 6, 1, 7

8, 5, 3, 4, 2, 7, 1, 6

8, 6, 4, 3, 2, 7, 1, 5

8, 6, 3, 4, 2, 5, 1, 7

8, 7, 3, 5, 2, 4, 1, 6

8, 7, 4, 6, 2, 3, 1, 5

8, 6, 4, 3, 2, 5, 1, 7

7, 8, 3, 5, 2, 4, 1, 6

8, 7, 4, 3, 2, 6, 1, 5

8, 4, 3, 6, 2, 5, 1, 7

8, 6, 4, 7, 2, 5, 1, 3

8, 4, 3, 7, 2, 6, 1, 5

8, 6, 4, 5, 2, 3, 1, 7

8, 6, 4, 5, 2, 7, 1, 3

8, 4, 3, 6, 2, 7, 1, 5

8, 5, 3, 6, 2, 4, 1, 7

8, 7, 4, 6, 2, 5, 1, 3

8, 6, 3, 7, 2, 5, 1, 4

8, 6, 3, 5, 2, 4, 1, 7

8, 7, 4, 5, 2, 6, 1, 3

8, 6, 3, 5, 2, 7, 1, 4

8, 7, 3, 4, 2, 5, 1, 6

8, 6, 3, 7, 2, 4, 1, 5

8, 7, 3, 6, 2, 5, 1, 4

7, 8, 3, 4, 2, 5, 1, 6

8, 6, 3, 4, 2, 7, 1, 5

7, 8, 3, 6, 2, 5, 1, 4

8, 7, 4, 3, 2, 5, 1, 6

8, 7, 3, 6, 2, 4, 1, 5

8, 7, 3, 5, 2, 6, 1, 4

8, 4, 3, 7, 2, 5, 1, 6

7, 8, 3, 6, 2, 4, 1, 5

7, 8, 3, 5, 2, 6, 1, 4

8, 4, 3, 5, 2, 7, 1, 6

8, 7, 3, 4, 2, 6, 1, 5

8, 5, 3, 7, 2, 6, 1, 4

8, 7, 4, 5, 2, 3, 1, 6

7, 8, 3, 4, 2, 6, 1, 5

8, 5, 3, 6, 2, 7, 1, 4

Test Practice Questions

- 1) C. The price per pizza isn't the same for 3 pizzas and for 4 pizzas. An equation would have to explain both prices.
- 2) B

Expressions, Equations, and Inequalities (Part 2)

- 3) D
- 4) B
- 5) D
- 6) C
- 7) C
- 8) Part A: C, Part B: B
- 9) D
- 10) D
- 11) 1160
- 12) Part A: D, Part B: A
- 13) C
- 14) B
- 15) B
- 16) B
- 17) C
- 18) A
- 19) B
- 20) B
- 21) Part A: B, Part B: A
- 22) C
- 23) Part A: B, Part B: C
- 24) A
- 25) B

Expressions, Equations, and Inequalities (Part 2)

- 26) C
- 27) A
- 28) C
- 29) B
- 30) B
- 31) A
- 32) D
- 33) D
- 34) Part A: A, Part B: C
- 35) Part A: A, Part B: B
- 36) Part A: D, Part B: A

The Language of Expressions, Equations, and Inequalities

- 1) Each paragraph should use the 4 vocabulary words in the circle on the left. Be creative. There is no one way to do this activity!
- 2) Optional: E-mail your letter to info@collectedny.org. Your letter may be featured on a website for teachers and students across New York State!

Vocabulary Review

You can use this section to look up words used in this math packet.

balance: a state of equilibrium; equal distribution of weight.

balance scale: a device for measuring the weight of objects

coefficient (noun): A number multiplied by a variable. For example, $4x$ is the same as 4 times x . 4 is the coefficient of x .

constant (noun): A value in an expression or equation that doesn't change. For example, in the expression $3w + 2$, the numbers 3 and 2 are both constants.

distributive property of multiplication (noun): a mathematical property that shows multiplying a number by a group of numbers added together is the same as doing each multiplication separately. For example, $3 \cdot (2 + 4)$ is equal to $3 \cdot 2 + 3 \cdot 4$.

equivalent: having the same value. For example, 4 quarters and 20 nickels are equivalent. Eight hours is equivalent to 28,800 seconds.

equal sign: a symbol used to show symmetric balance between two values or quantities, one on each side of the equal sign. Can be read as "is equivalent to" or "is the same as".

equation (noun): A number sentence that shows two expressions are equal by using the equal sign. $2^3 = 8$ is an *equation*. $5x + 3$ is an expression, not an *equation*.

equilibrium (noun): When things are balanced. An equation can be in a state of equilibrium. A country could also be in a state of equilibrium, if opposing forces are balanced.

equivalent (adjective): Having the same value. 4^3 and 64 are *equivalent*.

estimate (verb): To make a rough guess at a number, usually without making written calculations

evaluate (verb): To calculate the value of something. If asked to *evaluate* 4^3 , your answer should be 64.

expression (noun): Numbers and symbols that show the value of something. 100, $5x + 3$, and 2^3 are all *expressions*. $5x + 3 = 23$ is an equation made up of two *expressions*.

Expressions, Equations, and Inequalities (Part 2)

exponent (noun): In a quantity represented as a power, the *exponent* shows how many times the base is multiplied. The exponent is shown as a smaller number up and to the right of the base. For example, in the power 2^3 , the *exponent* is 3.

factor (noun): Whole numbers that are multiplied together to get another number. A number that can be divided into another number evenly, with no remainder.

factor (verb): To split a number into its factors (see above definition of factors).

generalization (noun): To look at specific examples and realize that something is true *in general*. For example, what happens when you divide a number by itself? Specific examples: $8 \div 8 = 1$ or $25 \div 25 = 1$ or $.75 \div .75 = 1$. *Generalization*: Any number divided by itself is 1.

inequality (noun): A number sentence that compares two values which do not have to be equivalent.

inverse (adjective): Opposite or reverse. Addition and subtraction are *inverse operations*.

multiple (noun): A number that can be divided by another number evenly, with no remainder. 25 is a *multiple* of 5.

numeral (noun): A symbol or name for a number. 12 and twelve are both *numerals*.

operation (noun): A mathematical process. The four basic operations are addition, subtraction, multiplication, and division. Exponents and roots are also operations.

parentheses (noun): These are parentheses: (). They are used for grouping operations that should be prioritized when calculating.

property (noun): A character or quality that something has. In science, we use the physical property to refer to color, texture, density, and other qualities of physical objects. In mathematics, properties refer to characteristics of numbers or operations. Example:

Commutative property: Addition and multiplication are *commutative*, meaning the order of the operation doesn't matter. $2 + 7 = 7 + 2$ and $2 \cdot 7 = 7 \cdot 2$

product (noun): The result of multiplication. 4 times 5 gives a *product* of 20.

quotient (noun): The result of division. 20 divided by 5 gives a *quotient* of 4.

radical (noun): A symbol that means "root." *Radicals* are used for square roots, cube roots, and other roots.

Expressions, Equations, and Inequalities (Part 2)

square root symbol: $\sqrt{\quad}$

rate (noun): a ratio with two different quantities that are being compared.

Examples: *Speed* compares distance traveled to the amount of time that has gone by.
Population density compares the number of people with the amount of space.

reciprocal (noun): If you multiply a number and its reciprocal, the answer will be 1. Another way of saying this is the *reciprocal* of a number is the result of dividing 1 by the number.

Examples: $3 \cdot \frac{1}{3} = 1$ $\frac{2}{3} \cdot \frac{3}{2} = 1$ $x \cdot \frac{1}{x} = 1$

right triangle (noun): a right triangle is a triangle with one 90° angle. In a right triangle, the side opposite the right angle is called the *hypotenuse*. The two sides that form the right angle are called *legs*.

root (noun): The solution to an equation, usually similar to $a^2 = 25$ or $a^3 = 8$

square root: A square root of a number is a value that, when multiplied by itself, gives the number. The *square root* of 25 is 5.

term (noun): A single number or variable, or numbers and variables multiplied together. Terms are separated by + or - signs. For example, there are three terms in the equation $2x + 5(2) = 16$.

like terms: Two or more terms with the same variable and exponents which can be combined in an expression. Example: $10w$, $.5w$, and $\frac{1}{2}w$ are *like terms* and can be combined to make $11w$.

unlike terms: Terms that do not have the same variable and/or exponents and cannot be combined in an expression. Example: $8v$, $7v^2$, and $4x$ are *unlike terms*.

variable (noun): A letter or symbol that represents another value, either any number, a specific number, or a set of numbers. In the expression x^3 , x is a *variable* that could mean any number. Variables can also represent other things. For example, in geometry, points and angles are represented by letters.

system of equations (noun): A set of two (or more) equations where the variables represent the same unknown values that make both equations true.

Sources

Booker, G. (2009). *Algebraic thinking: generalising number and geometry to express patterns and properties succinctly*. Griffith University. Brisbane. (Sections: Squaring and Multiplying, The Math Magic Trick)

Chapin, S. (2000). Math Matters: Understanding the Math You Teach. Grades K-6. Math Solutions Publications. (Section: Balance Scales)

Curry, D. 2007. *Integrating arithmetic and algebra*. The Math Practitioner (Spring 2007). The Adult Numeracy Network. (Sections: The Equal Sign, Number Sentences)

JMAP Regents Tests: <http://www.jmap.org> (Section: Inequalities, Test Practice Questions)

Manly, M., & Ginsburg, L. (2010). Algebraic Thinking in Adult Education. National Institute for Literacy. (Sections: The Multiplication Table, Equality)

Open Middle: <http://www.openmiddle.com>. (Section: Creating and Solving Equations)

Open Up Resources: <https://openupresources.org>. Source curriculum available for free at web site. (Section: Hanger Diagrams, Another Math Magic Trick, Like Terms, Inequalities)

Lonberg-Lew, S. Singapore strips: tools for making sense. The Math Practitioner (Spring 2018). The Adult Numeracy Network. (Section: Tape Diagrams)

SERP. AlgebraByExample: <https://math.serpmedia.org>. Source curriculum available for free at web site. (Section: Algebra Examples)

Steward, Don. <https://donsteward.blogspot.com>. (Section: Guess My Number)

Usiskin, Z. (1988). Conceptions of school algebra and uses of variables. *The ideas of algebra, K-12*, 8, 19. (Section: Introduction, Variables)

Van de Walle, J. A. (2003). Elementary And Middle School Mathematics. New York. (Sections: Guess My Number, Order of Operations, Create Equivalent Expressions)

Wickett, M., Kharas, K., & Burns, M. (2002). Lessons for Algebraic Thinking: Grades 3-5. Math Solutions. (Sections: The Equal Sign, Math Sentences - True/False)